

5G PPP

6G SNS  
IA

# The European 5G Annual Journal 2023

Supported by the





# THE EUROPEAN 5G ANNUAL JOURNAL/2023



Grant Agreement N°: 101069987  
Coordination and support action  
Call Identifier: HORIZON-CL4-2021-DIGITAL-EMERGING-01

## 6GStart Starting the Sustainable 6G SNS Initiative for Europe

# THE EUROPEAN 5G ANNUAL JOURNAL/2023



**6GStart**

The European 5G Annual Journal 2023 is the 7<sup>th</sup> and last edition of the European 5G Annual Journals. It presents major achievements and results of Phase 3 projects which are still running or recently ceased activity.

### *Disclaimer*

This report contains material which is the copyright of certain 6GStart Consortium Parties and may not be reproduced or copied without permission.

All 6GStart Consortium Parties have agreed to publication of this report, the content of which is licensed under a Creative Commons Attribution–NonCommercial–NoDerivs 3.0 Unported License .

Neither the 6GStart Consortium Parties nor the European Commission warrant that the information contained in the Deliverable is capable of use, or that use of the information is free from risk and accept no liability for loss or damage suffered by any person using the information.



CC BY-NC-ND 3.0 License – 2023 6GStart Consortium Parties



# TABLE OF CONTENT

Foreword from the European Commission.....	8
Introduction from the 6G Industry Association.....	10
Key 5G achievements.....	12
Contributions from projects.....	17

## 5G PPP Phase 3, Part 3: Advanced 5G validation trials across multiple vertical industries 18

5G-HEART.....	18
5G-SOLUTIONS.....	21
5G-VICTORI.....	23

## 5G PPP Phase 3, Part 4: 5G Long Term Evolution 26

ARIADNE.....	26
5G-CLARITY.....	29
5G-COMPLETE.....	31
INSPIRE-5Gplus.....	33
LOCUS.....	37
Mon5G.....	39
TERAWAY.....	41
5GZORRO.....	43

## 5G PPP Phase 3, Part 5: 5G Core Technologies innovation projects 47

5G-LOGINNOV.....	47
5GMETA.....	50
5GRECORDS.....	52
DRAGON.....	56
FUDGE-5G.....	58
Int5Gent.....	61

## 5G PPP Phase 3, Part 5: 5G for Connected and Automated Mobility 63

5GBLUEPRINT.....	63
5GMED.....	65
5GROUTES.....	68
5GRAIL.....	70

## 5G PPP Phase 3, Part 6: Innovations for verticals with third party services 73

5GASP.....	73
5G-EPICENTRE.....	75
5G-ERA.....	77
5G-IANA.....	79
5G-INDUCE.....	81
EVOLVED-5G.....	83
Smart5Grid.....	86
VITAL-5G.....	88

## 5G PPP Phase 3, Part 6: Smart Connectivity beyond 5G 91

6G BRAINS.....	91
DAEMON.....	94
DEDICAT 6G.....	95
Hexa-X.....	98
MARSAL.....	100
REINDEER.....	103
RISE-6G.....	105
TeraFlow.....	107
B5G-OPEN.....	109

## 5G PPP Phase 3 support: 6GStart CSA Project 112

## 5G Thematic Chapter 114

SME success stories and results from 5G PPP projects.....	114
SCoDIHNet activities.....	115
The EC H2020 5G Infrastructure PPP.....	117

## 5G events 119

5G/6G initiatives to date.....	119
Global 5G events.....	120

## Other events and initiatives 122

Workshops and webinars.....	122
White Papers and reports.....	123
Appendix 1: working groups.....	125
Appendix 2: acronyms and abbreviations.....	126



# LIST OF FIGURES

<i>Fig. 1: 5G PPP Reference Figure (2023 update)</i> .....	16	<i>Fig. 31: Use case Remote driving</i> .....	66
<i>Fig. 2: HIB remote guided/controlled ultrasound of the heart</i> .....	19	<i>Fig. 32: Use case Road Infrastructure Digitalisation</i> .....	66
<i>Fig. 3: Image quality</i> .....	19	<i>Fig. 33: Use case Future Railway Mobile Communications</i> .....	67
<i>Fig. 4: Tele-operated support (TeSo)</i> .....	19	<i>Fig. 34: Use case Follow ME Infotainment</i> .....	67
<i>Fig. 5: Camera data monitoring for fish behaviour</i> .....	20	<i>Fig. 35: Overview of the trial architecture</i> .....	68
<i>Fig. 6: Illustrated smart city and industrial landscape containing all the use cases envisaged by 5G-SOLUTIONS</i> .....	22	<i>Fig. 36: 5G private network Core and baseband unit</i> .....	69
<i>Fig. 7: 5G-VICTORI E2E Reference Architecture</i> .....	24	<i>Fig. 37: TOBA: Telecom Onboard Architecture</i> .....	71
<i>Fig. 8: ARIADNE Point-to-Point D-Band demonstrator architecture</i> .....	28	<i>Fig. 38: 5GASP Architecture</i> .....	74
<i>Fig. 9: RIS / Metasurfaces demonstration scenario</i> .....	28	<i>Fig. 39: 5G-ERA architecture and robots</i> .....	78
<i>Fig. 10: 5G-CLARITY Trials at Bosch Plants, Madrid, Spain; and MShed Museum, Bristol, UK</i> .....	31	<i>Fig. 40: 5G-IANA Network Application (nApp) Experimentation Platform</i> .....	80
<i>Fig. 11: 5G-Complete deployment options</i> .....	32	<i>Fig. 41: The 5G-INDUCE vision and the adopted approach for easy (i) porting and/or (ii) development of industry 4.0</i> .....	81
<i>Fig. 12: Demo 1 enablers and architecture</i> .....	35	<i>Fig. 42: Main concept depicting the Network Applications Orchestrator (NAO)</i> .....	83
<i>Fig. 13: Demo 2 architecture and network domain</i> .....	35	<i>Fig. 43: Abstract illustration of the CAPIF functionality, with representative examples of its applicability</i> .....	84
<i>Fig. 14: Demo 3 architecture</i> .....	36	<i>Fig. 44: NEF Emulator's simulated environment</i> .....	85
<i>Fig. 15: LOCUS architecture</i> .....	37	<i>Fig. 45: VITAL-5G platform and test-beds integration</i> .....	89
<i>Fig. 16: Overview of the LOCUS PoCs</i> .....	39	<i>Fig. 46: Warehouse/freight logistics - Athens facility</i> .....	90
<i>Fig. 17: Mon B5G framework</i> .....	40	<i>Fig. 47: 6G BRAINS enabled use case (images: Bosch)</i> .....	93
<i>Fig. 18: The PolyBoard comprises the tuneable lasers, optical isolators and a waveguide routing network to interconnect the different photonic functionalities</i> .....	42	<i>Fig. 48: DEDICAT 6G concept</i> .....	96
<i>Fig. 19: TERAWAY Demo Architecture</i> .....	43	<i>Fig. 49: High level view of DEDICAT 6G architecture</i> .....	97
<i>Fig. 20: Koper Living Lab Use Cases highlights: Mobile Network and Services Automation; 5G and IoT Assisted Port Control; Drone based video streaming</i> .....	48	<i>Fig. 50: View of DEDICAT 6G use case pilots testing and validation activities</i> .....	97
<i>Fig. 21: Hamburg Living Lab Use Cases highlights: Floating Truck and Emission Data; 5G GLOSA and Truck Platooning; 5G DCET</i> .....	49	<i>Fig. 51: Hexa-X 6G vision and key research challenges</i> .....	98
<i>Fig. 22: Athens Living Lab Use Cases highlights: 5G Connected Yard Trucks; 5G and IoT Video Analytics via NFV-MANO Support; 5G Connected External Trucks</i> .....	49	<i>Fig. 52: MARSAL architecture</i> .....	101
<i>Fig. 23: 5G-META platform</i> .....	51	<i>Fig. 53: Design and operations of Reconfigurable Intelligent Surfaces (RISs) for intelligent control of the wireless propagation medium</i> .....	106
<i>Fig. 24: Live audio production scenario</i> .....	54	<i>Fig. 54: The concept of wireless environment as a service brought by jointly optimising the lower network levels for achieving different performance objectives within the same environment</i> .....	106
<i>Fig. 25: Figure 25: Multiple camera wireless studio</i> .....	54	<i>Fig. 55: TeraFlowSDN controller cloud-native architecture</i> .....	108
<i>Fig. 26: Live immersive media production scenario</i> .....	55	<i>Fig. 56: : B5G architecture</i> .....	110
<i>Fig. 27: DRAGON phased array architecture and demonstrator</i> .....	57	<i>Fig. 57: 5G PPP and SNS-JU programmes</i> .....	113
<i>Fig. 28: FUDGE 5G architecture</i> .....	58	<i>Fig. 58: 5G PPP key achievements 3.2</i> .....	118
<i>Fig. 29: Int5Gent architecture</i> .....	62		
<i>Fig. 30: 5GBLUEPRINT use cases</i> .....	64		





# LIST OF TABLES

---

*Table 1: 5G PPP R&I programme Highlights & Major Results Overview..... 15*

*Table 2: Key Performance indicators ..... 20*

*Table 3: Average results from the feedback ..... 20*

## Foreword from the European Commission



**Peter Stuckmann,**  
Interim Executive Director of the Smart  
Networks and Services Joint Undertaking and  
Head of Unit, Future Connectivity Systems at  
European Commission

At this point in time, it is worth looking back at the 5G PPP Programme and its achievements as the final projects will be winding up in 2023 and 2024.

5G PPP was built around three phases: while Phase 1 performed fundamental research for the 5<sup>th</sup> generation of network communications, Phases 2 and 3 focused on proof of concept, technology validation and ecosystem building, directly involving users. An important enabler was the development of validation platforms that allowed the testing of 5G applications on real multi-vendor equipment. Examples include X-haul, network applications and orchestration of the different layers, with 5G for Connected and Automated Mobility (CAM), Public Protection and Disaster Relief (PPDR) and other verticals, such as ports and logistics, coming to test and validate advanced applications on top of the platforms.

The outcome is impressive! €713 million dedicated to research, innovation and to delivering solutions, architectures, technologies and standards for building a ubiquitous 5G communication infrastructure in Europe: 93 funded projects, 1,845 participants and 789 unique beneficiaries, involving nearly 85,000 persons/month. 40+ White Papers produced and over 2,500 scientific publications thus far. It has also had a major impact on 5G standards thanks to ongoing contributions to standards organisations. One prime example: 5G PPP projects provided over 800 contributions to 5G standardisation globally.

There has also been no shortage of success stories over time.

The METIS-II (Mobile and Wireless Communications Enablers for Twenty-twenty Information Society II) project created an overview of the different technologies and variants for 5G, pushing for harmonisation of the very fragmented 5G design space. It helped to quantify the performance of 5G technology in various use cases and served as an important benchmark for the 5G research community. Building on the successful METIS-I project, a predecessor in the 7<sup>th</sup> EU Framework Programme (FP7) which investigated emerging key technology components towards future communication systems, METIS-I and METIS-II projects are recognised



worldwide as EU flagships that initiated the road to 5G and led to the success of 5G PPP.

With the final 5G PPP phase (Phase 3) still ongoing, we continue to expand 5G capabilities and facilitate applications development. The seven 5G PPP CAM projects, for instance, delivered operational cross-border connectivity with multiple advanced CAM applications such as collision avoidance and remote teleoperation.

But the final phase of 5G PPP also looks beyond current network technologies: the Hexa-X flagship and its nine projects under Phase 3.6 Smart Connectivity and Beyond 5G, as well as the newly begun Hexa-X-II, under the European Smart Networks and Services Joint Undertaking (SNS JU), are research initiatives across the industry ecosystem to accelerate and foster 6G research and drive European leadership in the 6G era, with a similar intention as METIS-I regarding emerging technologies, and with an additional focus on sustainability, societal issues, and Key Value Indicators (KVI).

Without top performance connectivity, we cannot achieve any digital ambition. That is why the EU has set the target of providing Gigabit connectivity to all European households and 5G coverage in all populated areas by 2030. Europe is at the midway point with 5G. With 5G coverage standing at 72% (even if not standalone), first-stage rollouts are on a solid footing, and Europe is strong on vertical trials, but full commercial 5G is still expected to be implemented widely, notably in industrial applications, and generate revenue.

Now that the Smart Network and Services (SNS) Joint Undertaking is a reality, the 35 Call 1 projects launched in January 2023 and Call 2 just closed, Europe is set to explore 5G Advanced as a basis for the final phase of 5G standards and to prompt 6G Research and Innovation (R&I) already at full scale.

As Europe looks to the future, now is the time to build on the successes of 5G PPP!



## Introduction from the 6G Industry Association



Colin Willcock,  
Chairman of the SNS JU Governing Board  
and 6G-IA Board

2022 was the year where we have gradually started to return to a normal mode of operation, after the Covid pandemic. With hard work and out of the box thinking, the 5G PPP community managed to keep the pace for research and innovation breakthroughs through these difficult times. Although the 5G PPP era is slowly coming to a close, in 2022 more than 40 projects were active, working on key areas for core technology innovation, service provision for verticals (including a dedicated group of projects dedicated to connected and automated mobility) and smart connectivity beyond 5G. This annual journal presents their key results and achievements during the reporting period. As you will see, the outcome of these projects is already forming the needed technological bridge to connect the 5G to the 6G era. Moreover, in this document you will find information about some key facts for the overall 5G PPP programme, including key milestones and achievements. Finally, this document includes information on two key focus areas, the involvement of Small and Medium Enterprises (SMEs) in the Programme and the expansion of the 5G community to include as many stakeholders as possible. This special thematic chapter includes information about the SME participation and success stories as well as activities related to the 5G Digital Information Hubs.

The research and innovation activities in Europe are now entering a transition phase. The work for 6G networks has already started under the umbrella of the Smart Networks and Services (SNS) Joint Undertaking. The SNS programme has been designed in a way to ensure continuity and directionality of funding by taking advantage of the excellent outcome of the 5G PPP Programme, whilst at the same time trying to align and leverage parallel activities from related Partnerships and MS national initiatives to ensure Europe's leading position in mobile communications in the next decade.





# KEY 5G ACHIEVEMENTS

---

Commercial 5G launches began in 2018 and have been accelerating since 2019. Four years after its launch, 5G is maturing and 6G is on track. The telecom industry is still under pressure to provide seamless, fast and reliable 5G connections, and has made and is still making large investments to satisfy demand. The heavy investments have been in coverage and new features.

Private 5G is gaining traction: it brings cutting edge connectivity that improves processes and powers new applications with automation, autonomy, and assistance applied in several verticals from manufacturing to mining, etc.

## 5G now live in advanced markets including in each EU Member State and in less advanced countries

Mobile network operators continue to deploy 5G despite geopolitical and economic uncertainty. At the end of 2022, 200+ 5G networks were scheduled to be deployed in more than 80<sup>1</sup> countries around the world. It is becoming mainstream in advanced wireless markets, overtaking early adopters. In Europe, commercial 5G is available in all 27 Member States.

Deployment of 5G StandAlone (5G SA) – sometimes referred to as ‘true’ 5G, which came into existence alongside new features and 5G Advanced – also continues to progress. The goal is to shorten time-to-market and enable data and bandwidth-intensive services (video streaming, Augmented Reality/Virtual Reality, immersive media) by introducing 5G SA functionalities including network slicing and Radio Access Network (RAN) virtualisation. As to subscriber numbers, the 1 billion mark was reached in 2022 globally<sup>2</sup>. Most common end-user 5G services include Enhanced mobile broadband (eMBB), gaming and cloud gaming, AR/VR services and 5G Fixed Wireless access (FWA) services. The pace of commercial launches of private network has been increasing, building on successful trials.

---

1. World 5G markets, 2022, IDATE, <https://en.idate.org/product/world-5g-markets-data-forecasts-up-to-2027-2/>

2. World 5G markets, 2022, IDATE, <https://en.idate.org/product/world-5g-markets-data-forecasts-up-to-2027-2/>

## 5G has entered a new stage of innovation

Since pioneer launches in 2018, 5G has been widely adopted in advanced markets, including every EU-27 Member State since early 2022, and is spreading in less advanced markets. Changes are occurring as the technology matures. Release 18 kicks off the 5G Advanced evolution and paves the way for new and enhanced features in upcoming releases.

### Innovative 5G devices expected to support 5G expansion and adoption

According to the Global mobile Suppliers Association (GSA), common devices including smartphones, Customer Premises Equipment (CPEs), modules, USB terminals, laptops and hotspots make up the bulk of announced and commercially available 5G devices. Drones, head-mounted displays, robots, TVs, cameras, femtocells/small cells, repeaters, on-board/in-car units, plug-in dongles/adapters, switches, vending machine and encoders account for 5%.

However, big tech companies such as Apple and Microsoft, major manufacturers and start-ups alike are devoting large Research and Development (R&D) budgets to the design of new devices. As a result, new concepts are emerging in a wide variety of areas, for both consumer and business markets, and in four main areas: wearables, robots, connected vehicles and connected objects. Some of them are still in the experimental stage, such as connected lenses, exoskeletons, companion robots. Other devices have started to spread, such as connected glasses and virtual reality (VR) headsets, with positive market growth forecasts. Industrial and personal robots are also expected to enjoy strong growth.

### 5G spectrum assignments have reached a turning point

5G has also reached a turning point with respect to spectrum. Advanced markets have been assigning spectrum for 5G since 2015 and have made complementary frequency bands available to meet 5G requirements in an optimal fashion.



Operators use a combination of frequency bands to optimise 5G service delivery. The use a mix of low-band (below 1 GHz), which provide virtually blanket coverage, mid-band (1–6 GHz), providing both coverage and capacity, and high-band frequencies (over 20 GHz), which deliver very high data throughput over a short distance, is critical. In Europe, 5G pioneer bands have been identified and harmonised since 2019. The combined use of several frequency bands has consequences on throughput and coverage.

Most commercial 5G networks use mid-band frequencies at 3.5 GHz, some use the mmWaves spectrum of lower frequencies along with dynamic spectrum sharing solutions to take advantage of low-band frequencies.

### Improved coverage

When 5G launched back in 2018, population coverage was very spotty. Significant progress has been made since then, and 5G mobile network operators continue to step up efforts to improve population coverage, though disparities still exist between outdoor and indoor coverage levels. Outdoor coverage in many countries has now reached levels of 80% to virtually 100%. In the European Union, average outdoor population coverage exceeded 70% at the end of 2022<sup>3</sup>.

Providing increased 5G indoor coverage remains a critical issue as higher frequencies have difficulty penetrating buildings. It will also require the installation of many indoor cells, with the added complication of having to involve venue owners (stadiums, airports...) in indoor 5G network deployments.

### Private networks and verticals

A 5G private network is a dedicated network, based on 5G technologies, acting as a local area network to provide a secure means of communication in a specific area, combined with unified connectivity. A private mobile network is suitable for a range of different fields, from enterprise Internet of Things (IoT) services to Smart City applications. Large companies have been the most prominent early adopters, using private networks for specific wireless connectivity needs. Public and commercial sites, such as stadiums and vertical industries, deliver bespoke connectivity.

The allocation of dedicated spectrum has substantially increased demand for private networks in Germany, France, the UK, Japan and the USA.

Trials are still the most common form of undertaking, seeking to demonstrate private 5G networks' technical feasibility and proof of value, but a host of effective launches is expected in the coming months and years. Smart manufacturing accounts for the bulk of private 5G deployments, most notably in the automotive, aeronautics and electronics manufacturing sectors.

## Memorandum of Understandings (MoU) and agreements

MoUs have paved the way for smooth global cooperation since 2015. Memorandum of Understandings continue to be signed to keep the momentum going. 5G Americas (Americas), The Fifth Generation Mobile Communications Promotion Forum (5GMF) (Japan), 5G Forum (Republic of Korea), IMT-2020 Promotion Group (5G) (non-profit organisation, China), 5G Brasil under the Telebrasil umbrella (Brazil), TSDSI (India) and the 5G IA/6G-IA (5G/6G Infrastructure Association, Europe) all testify to the need for a global and common 5G promotion effort.

These MoUs go beyond 5G and now also include cooperation on 6G (IMT 20230 (6G) Promotion Group and 6G-IA, Beyond 5G Promotion Consortium and 6G-IA, AENEAS and 6G-IA, the 5GAA (5G Automotive Association) and 6G-IA, ETSI (European Telecommunication Standards Institute) and 6G-IA).

## As 5G networks continue to develop, 6G is already in the works

6G is the sixth generation of mobile networks, and currently under development in Europe and other regions around the world. Commercial 6G deployments are anticipated to take place around 2030–2035. The new technology has not yet been fully designed, and specifications are expected to be fully established and released by the 3GPP and International Telecommunication Union (ITU) around 2025.

Under the 5G PPP programme, nine Phase 3 part 6 projects launched early 2021 cover smart connectivity beyond 5G, namely: 6G-BRAINS,

3. The 5G Observatory- <https://5gobservatory.eu/>



AI@EDGE, DAEMON, DEDICAT 6G, Hexa-X, MARSAL, REINDEER, RISE-6G, and TeraFlow.

Preliminary studies and reflections have helped identify basic functionalities and requirements. 6G – which will likely be much faster than 5G – will transmit data using ultra-high frequencies, across waves in the hundreds of Gigahertz (GHz) or Terahertz (THz) ranges, taking advantage of significant unused spectrum. In other words, 6G will rely on the use of multiple frequencies, and will deliver much higher energy efficiency, network reliability, security, personalisation, accuracy and ubiquity. It will leapfrog the 5G path to provide global, rather than just local, significantly faster, and ultra-low latency connectivity, and will connect substantially more devices to the network.

Moreover, the 6G network is speculated to be distributed, decentralised, and intelligent and so achieve a truly trustworthy infrastructure, in addition to reducing its energy, resources, and carbon emissions footprint.

## Reducing the environmental impact and making networks greener

Environmental awareness has been steadily emerging as a key design factor for new mobile networks. Mobile Network Operators (MNOs) have committed to reducing the environmental impact of mobile networks and their operation.

Efforts have been focused primarily on reducing energy consumption per bit of data by a factor of ten, compared to 5G. Network operators have also begun replacing old equipment with new configurations and by adjusting existing ones, including Multiple Inputs Multiple Outputs (MIMO) and the number of bands deployed, according to each site's traffic profile and improving cooling systems.

MNOs are also leading the path for the reduction of greenhouse gas emissions, aided by novel applications such as eHealth, e-Education, etc.

## Significant past milestones

The 5G PPP Programme can be considered a successful pan-European action. Since its inception it has provided significant achievements in multiple areas, making Europe a global standard-bearer in research and innovation actions for

5G networks. More specifically, 5G PPP has provided:

- **A plethora of significant scientific and technological results:** Through its three phases, the 5G PPP have provided multiple 5G and Beyond 5G (B5G) technological solutions in specific areas and on an end-to-end framework. Several of these solutions have been submitted to various standardisation bodies and eventually implemented in some cases.
- **Significant technical input to the standardisation bodies:** 5G PPP has been an active contributor to 5G standardisation globally. During its lifetime more than 800 contributions to standardisation bodies have been recorded.
- **Impact through scientific publications:** Moreover, data collected from the funded projects' public sites reveal a significant impact on the scientific community (more than 2,500 publications throughout the duration of the 5G PPP programme).
- **Measurable Programme progress and KPIs:** 5G PPP has managed to fulfil all key Programme KPI targets<sup>4</sup>, including: a) the mobilisation of Europeans resources with more than 700 stakeholders participating in 5G PPP Research and Innovation Action (RIA) and Innovation Action (IA) projects; b) the creation incentives for private-sector funding that exceeds overall public funding; c) mechanisms to ensure that more than 20% of the funding was directed to SMEs. Finally, specific 5G technological KPIs (performance, business and societal) have also been addressed successfully.
- **Optimum profile for the European 5G initiative in a global context:** Through the 6G-IA, the 5G PPP community has 15 Memorandums of Understanding (MoUs) in place and four Letters of Intent (LoI) with international peer associations, verticals' associations, Standard Development Organisation (SDOs) etc. promoting European outputs at a global forum.
- **Widespread dissemination of European achievements: During its entire lifespan, the 5G PPP Initiative** has been actively engaged in organising and disseminating results and achievements through hundreds of physical, hybrid and virtual events. 5G PPP had the

4. [https://5g-ppp.eu/wp-content/uploads/2022/06/white\\_paper\\_b5g-6g-kpis-camera-ready.pdf](https://5g-ppp.eu/wp-content/uploads/2022/06/white_paper_b5g-6g-kpis-camera-ready.pdf)



possibility to present its achievements, raise awareness on opportunities offered by 5G and interact with major EU and international organisations at multiple major events.

• **An efficient and effective 5G PPP Programme:** The 5G PPP Programme has been operating smoothly throughout its existence, having contracts for 93 projects during all three phases.

## Major innovations

The 5<sup>th</sup> Generation Public Private Partnership (5G PPP) programme has led the European Research & Innovation (R&I) on 5G connectivity over the past decade and is gradually coming to conclusion with the completion of most of the remaining funded R&I projects by the end of 2023 (the programme will officially wrap-up by mid-2024). Since its establishment in 2014, the 5G PPP programme has funded *93 R&I projects*, grouped in three phases, focused on 5G technology research, development, and validation, with

the participation of more than *700 EU-based beneficiaries*.

Over this past decade, all 93 5G PPP projects have contributed significantly to the advancement, validation and utilisation of 5G technologies, evidenced by the large number of scientific publications, as reported at the annual 5G PPP *Progress Monitoring Report (PMR)*<sup>5</sup> – to be updated shortly with the 2022 figures used here – as well as by the large number of contributions to standardisation activities (based on reports from the 5G PPP Pre-Standardisation Working Group) and innovation recorded with the EU Innovation Radar<sup>6</sup>. The latter is also a strong indication that the work performed in 5G PPP projects has had a real-world impact, through the development and validation of exploitable solutions.

Table 1 provides an overview of the 5G PPP R&I programme highlights and major achievements.

5. <https://5g-ppp.eu/annual-progress-monitoring-reports/>

6. <https://www.innoradar.eu/>

Category	Achievement
Contributions to standardisation activities	800+
Scientific Publications	2 500+
White Papers	45+
Innovations (EU Innovation Radar)	445
Phase 1 Key Achievements <sup>1</sup>	57
Phase 2 Key Achievements <sup>2</sup>	60
Phase 3 Key Achievements <sup>3</sup>	129

Table 1: 5G PPP R&I programme Highlights & Major Results Overview

During each of the three phases of the 5G PPP programme, all funded projects have worked closely together through the commonly established bodies of the *Steering Board (SB)* and *Technology Board (TB)*, while dedicated experts exchange views, insights and knowledge on specific technological areas via the instantiated technical *Working Groups (WGs)*<sup>7</sup>. Through these cross-project collaborations, it has become possible to generate commonly accepted conclusions and insights (as reported in the 5G PPP White Papers) and to keep track of all the **Key Achievements** of the various projects in each

phase of the 5G PPP. These achievements (listed in Table 1) cover various technological areas such as RAN and core systems and components, spectrum utilisation, network architecture and performance evaluation frameworks, network management and orchestration, security and privacy, application in vertical sectors and many more. A final list of key achievements will be produced for 2023, reflecting the achievements of the still ongoing projects as well.

The three phases of the 5G PPP programme have been set up by EU experts to reflect the current trends in Information and Communications Technologies (ICT) and to ensure that EU institutions and organisations have a strong foothold

7. <https://5g-ppp.eu/5g-ppp-work-groups/>

and gain expertise in key upcoming technological areas that will play a crucial role in future networks. To ensure that Europe targets technological sovereignty in all key technical areas and in order to boost and promote cross-project collaborations on commonly addressed topics, the 5G PPP TB periodically generates a **Reference**

**Figure** which lists the technological areas that each of the running projects are impacting. The latest Reference Figure<sup>8</sup> reflecting the active projects of 2023 is listed in Figure 1.

8. <https://5g-ppp.eu/5g-ppp-reference-figure/2023/>

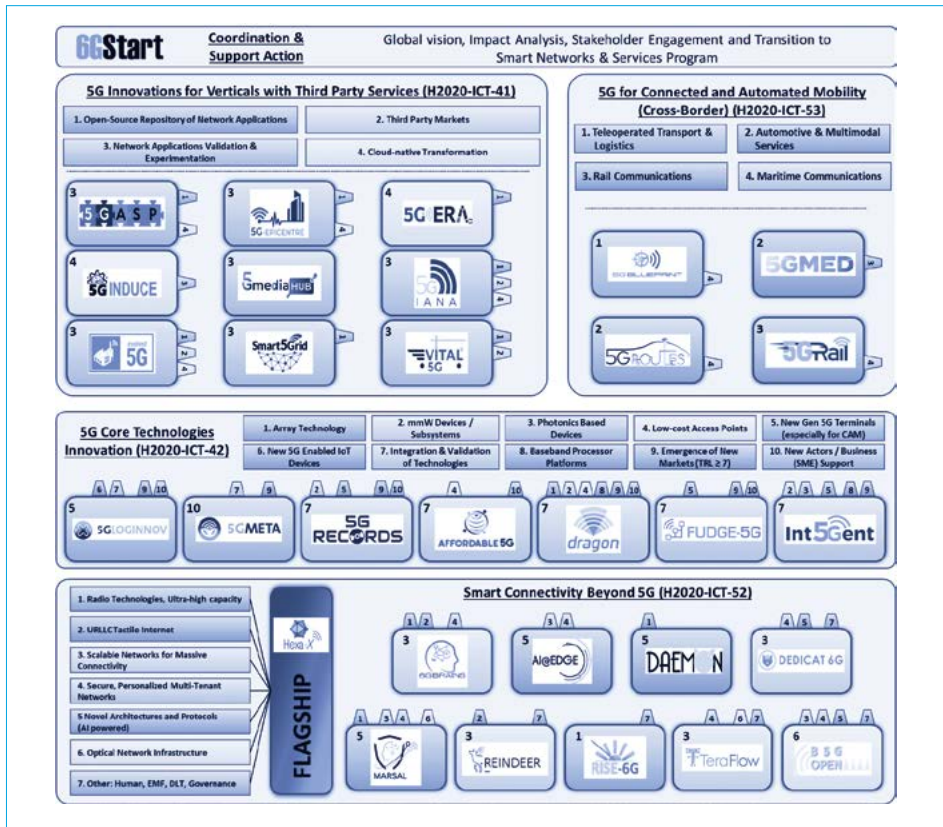

Fig. 1: 5G PPP Reference Figure (2023 update)<sup>9</sup>

9. <https://5g-ppp.eu/5g-ppp-work-groups/>

Aside from the above working areas and achievements, 5G PPP projects are regularly involved in 6G-IAb and NetworkEurope **Strategic Research and Innovation Agenda (SRIA)** activities, which will define the future research topics for the upcoming 6G networks. By sharing their insights, results and lessons learned,

5G PPP projects are already working on defining an EU R&I roadmap which will lead to the development of the necessary 6G technologies and solutions, and pave the way for the EU's digital and green transitions. The contributions of each project to SRIA activities are listed in the latest PMR<sup>10</sup>.

10. <https://5g-ppp.eu/annual-progress-monitoring-reports/>

# CONTRIBUTIONS FROM PROJECTS

---

This chapter presents contributions from Horizon 2020 (H2020) projects for phase 3 still active or recently closed. The currently ongoing Research & Innovation projects under the 5G PPP umbrella are part of the last phase of the 5G PPP, namely Phase 3. Some projects under phase 3.4<sup>11</sup> are still ongoing but the majority of running projects are on phase 3.5<sup>12</sup> 5G Core and CAM projects and phase 3.6<sup>13</sup>: 5G Innovations and Beyond 5G.

The projects under these two phases address the needs of four different R&I calls for proposals under the H2020 Work Programme, which are:

- H2020-ICT-41: 5G Innovations for Verticals with Third-Party Services
- H2020-ICT-42: 5G Core Technologies Innovation
- H2020-ICT-52: Smart Connectivity Beyond 5G
- H2020-ICT-53: 5G for Connected and Automated Mobility (Cross-Border)

The remainder of this section presents the overview, objectives and key achieved results to date.

---

11. <https://5g-ppp.eu/5g-ppp-phase-3-4-projects/>

12. <https://5g-ppp.eu/5g-ppp-phase-3-5-projects/>

13. <https://5g-ppp.eu/5g-ppp-phase-3-6-projects/>

# 5G PPP PHASE 3, PART 3: ADVANCED 5G VALIDATION TRIALS ACROSS MULTIPLE VERTICAL INDUSTRIES

The eight projects<sup>14</sup> retained in response to the 5G PPP ICT-19-2019 call started in June 2019.

14. <https://5g-ppp.eu/5g-ppp-phase-3-3-projects/>

## 5G-HEART

### 5G HEalth AquacultuRe and Transport validation trials

Coordinated by Haesik Kim (VTT)

June 2019-November 2022

Website: [5gheart.eu](http://5gheart.eu)

Twitter: @5gheart

#### Objectives

The **objective** of the 5G-HEART (5G HEalth AquacultuRe and Transport validation trials) was to define and validate the cost efficient 5G converged network concepts, which enabled an intelligent hub supported by multiple vertical industries. 5G-HEART performed vertical validation trials from three different vertical domains: healthcare, transport, and aquaculture. The healthcare vertical trials were structured under three high-level use cases: "Remote Interventional support", "Automatic pill camera anomaly detection", and "Vital-sign patches with advanced geolocation". The transport vertical trials were structured under four high-level use case categories: "Platooning", "Automated/assisted driving", "Support for remote driving" and "Vehicle data services". The aquaculture vertical trials were structured under five scenarios "Sensory data monitoring", "Camera data monitoring", "Automation and Actuation Functionalities", "Edge and cloud-based computing" and "Cage to cage on site communication".

#### Main results and innovations

Key results of 5G-HEART from three vertical trials are summarised as follows:

##### H1B – Remote guided/controlled ultrasound of the heart

The robot used is a collaborative, industrially available robot from Universal Robots, of model UR5. It was controlled with a haptic device, from SensAble technologies, model: Phantom Omni. There was a force-torque sensor mounted on the robot, enabling haptic force feedback to the controller. The ambient video was relayed by to webcams showing the position of the robot end-effector, where the ultrasound probe was mounted, relative to the healthy volunteer's body, laying on a bench.

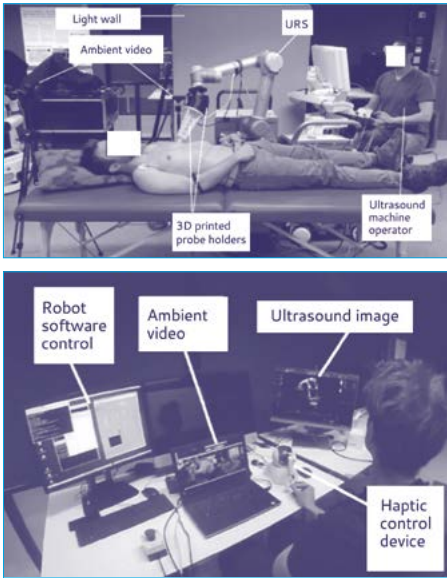

Fig. 2: HIB remote guided/controlled ultrasound of the heart

The ultrasound examination was made up of a simplified but comprehensive imaging of the left heart side. The robotic examination lasted for 26.4 minutes on average and was 1.92 times longer than the reference exam. There was a significant difference in rated image quality,

where the reference reached a mean value of 2.5 and the robotic examination 1.5 on a predefined scale where grade 0 was "unusable quality", 1 was "low quality", 2 was "medium quality" and 3 was "good quality" (see figure 3).

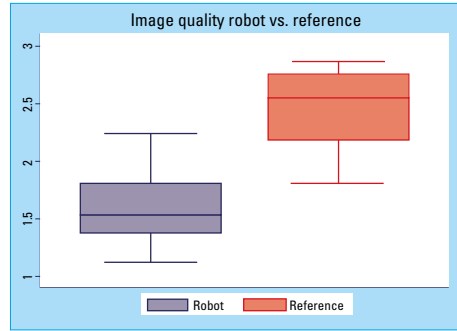

Fig. 3: Image quality

### T3S1 Tele-operated support (TeSo)

Tele-operated support (TeSo) refers to the remote control of a vehicle using the available mobile network infrastructure. A human operator located remotely sends control commands to the vehicle over the network, while at the same time, information about the vehicle's state and its surroundings is properly transferred and visualised back to the operator.

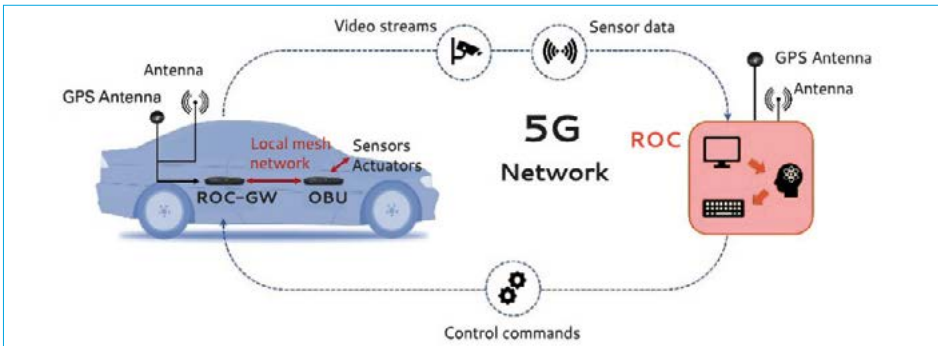

Fig. 4: Tele-operated support (TeSo)

The table next page presents the computed Key Performance Indicators (KPIs) per individual

data stream for a specific trial iteration of TC01 Straight manoeuvre.

Data Stream	Mean Lat. ( $\mu$ s)	Mean Throughput ( $\mu$ s)	Jitter (bps)	Loss Rate (%)
GNSS Pos.	30159.16	4651.69	9149.09	0
Front Cam.	42378.31	2165787.34	7730.31	0.053820
Back Cam.	40180.17	1490055.50	6375.40	0
Right Cam.	38176.08	1436088.75	8467.67	0.043837
Left Cam.	44091.86	1643104.52	8520.49	0.041779
Throttle Ctrl.	24432.25	220.72	3915.70	0
Brake Ctrl.	24633.00	22.30	5245.50	0
Wheel Ctrl.	25190.55	7088.25	5144.67	0
Vehicle State	30791.02	4257.11	8893.27	0
Autom. State	30882.94	4180.73	9533.60	0.103627

Table 2: Key Performance indicators

### A1S2 – Camera data monitoring

Fish behaviour, disease and feeding as well as infrastructure monitoring are very important aspects of modern aquaculture. Efficient identification and management of the various incidents that may come up during production is crucial for the welfare of the fish as well as for the maintenance of the infrastructure. The availability of camera streams transmitting the current status of the site aimed to face current practices that include frequent visits on site and thus, additional effort for the operator. The two figures below show example under water images with good quality (above) and bad quality (below).



Fig. 5: Camera data monitoring for fish behaviour

The table below presents average results from the feedback with a score of 1 to 10, where 1 is worst and 10 is best.

Statement	Scoring 1-10
Image quality while still	8
Image quality while moving	7
Pan/tilt reaction time	5
Video stream is realtime	8
Image quality 2 streams	8
Image quality 3 streams	5
Image quality >3 streams	3
Overall experience	7
Average score:	6.15

Table 3: Average results from the feedback

### Vertical use cases addressed in 5G PPP

Agriculture and agrifood, Automotive, eHealth and wellness, Smart airports/ports

## 5G Solutions for European citizens

Coordinated by Andrea Di Giglio (Telecom Italia)

June 2019-June 2022

Website: <https://www.5gsolutionsproject.eu>

Twitter: @5g\_solutions

### Objectives

5G-SOLUTIONS aimed to validate that the 5G capabilities provide prominent industry verticals with ubiquitous access to a wide range of forward-looking services with orders of magnitude of improvement over 4G, thus bringing the 5G vision closer to realisation. This was achieved through conducting advanced field trials of 20 innovative use cases, implementing using the EU supported testbeds 5G-EVE and 5G-VINNI facilities in Italy, Norway, Greece, Ireland, and Belgium and by directly involving end-users from five significant industry vertical domains referred to as Living Labs:

- Factories of the future
- Smart Energy
- Smart Cities
- Smart Ports
- Media & Entertainment (M&E)
- Multi-lab: validating a mix of Use Cases from several verticals

5G-SOLUTIONS also validated the new businesses and frog-leap performance advantages in digital content production and consumption, thus connecting and voicing the European communities in the virtual domain as well.

### Description of demos, trials and use cases

5G-SOLUTIONS defined 20 use cases, and analysed the requirements derived from them, the performance indicators, the KPIs (in more than 140 test campaigns) that were measured and assessed to validate them, the test cases and scenarios, the collection and analysis of the results, and the methodology of the whole process. To establish the benefits brought about by 5G, the project defined both the technical

KPIs as well as looking into the business KPIs and value propositions arising for each of these promising use cases.

As part of the validation process 5G-SOLUTIONS provided and developed technological enablers to facilitate and automate such large-scale process across all use cases and testbeds. These enablers included: a service orchestrator enabling multi-domain slicing and 5G service lifecycle automation; an innovative KPI visualisation system to facilitate near real-time analysis, presentation, benchmarking, and performance validation of 5G network as well as Applications level KPIs; and intent-based APIs for stimulating innovation and fostering the development, portability and provisioning of new innovative applications by SMEs.

The experiments in 5G-SOLUTIONS were conducted over 3 cycles, slightly changing the scope and objectives of the tests, but, above all, exploiting the “lessons learned” of the previous cycles.

The result was the practical demonstration of one of the most important and innovative features of 5G, namely the use of logical subnets with different transmission characteristics, adapted to the needs of the service they are carrying, commonly called “slices”.

Figure 6 depicts a smart city where all the use cases envisaged and tested by 5G-SOLUTIONS are exploited. To prepare for and facilitate this anticipated outcome, main Partners, in particular big industries, and SMEs had produced an exploitation plan and, in parallel with the technical verifications, evaluations were carried out from an economic and social point of view, with decidedly encouraging results, both from the point of view of social acceptance and through business plans that show how the use cases are potentially very economically advantageous.

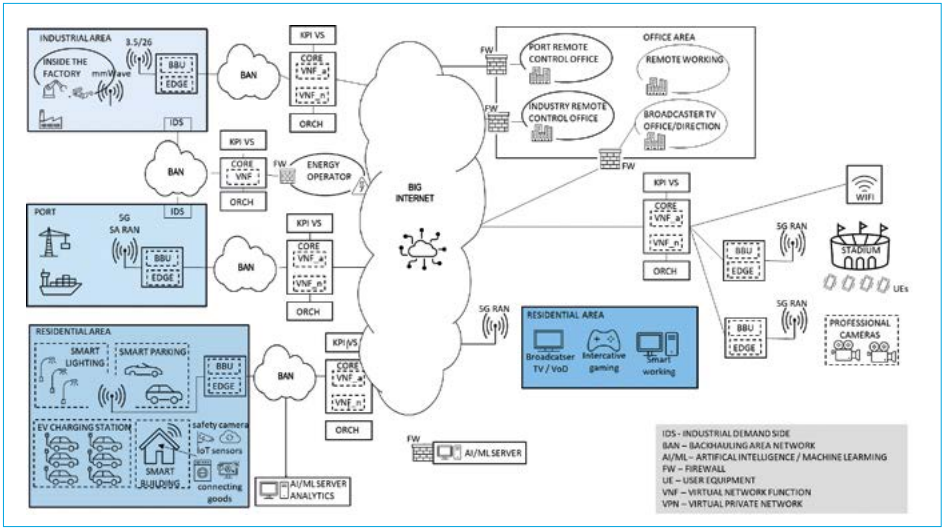

Fig. 6: Illustrated smart city and industrial landscape containing all the use cases envisaged by 5G-SOLUTIONS

In addition to technical and economical evaluations, as 5G is recognised to be a disruptive technology for citizens and society lives, and the social acceptance of these technologies has been assessed through the four living labs and the multi living lab as well. This assessment provided a large consensus with an overall good result (i.e., overall score of 73% for propensity to adopt), as well as it provided a tool to identify ethics and social concerns and relative counter-measures (policy options) to be considered for next calls and developments of Next Generation Mobile networks (i.e., 5G and beyond).

5G-SOLUTIONS also disseminated and exploited its technical and business results. As the project partners come from the academics, research, cellular operator and vertical domains, dissemination into non-partners coming from these worlds and exploitation within the products of the partners in these worlds are imminent. Similarly, as partners are members in standard bodies such as the 3GPP (3<sup>rd</sup> Generation Partnership Project), ETSI, ITU-T, IETF (Internet Engineering Task Force), ONF (Open Networking Foundation) and in various 5G PPP EU frameworks and other H2020 projects, cross-knowledge dissemination have been achieved.

#### Vertical use cases addressed in 5G PPP

**Energy, Industry 4.0, Media and Entertainment, Smart cities and utilities, Smart airports/ports**



## Vertical demos over Common large scale field Trials for Rail, energy and media Industries

Coordinated by Jesus Gutierrez Teran (IHP Leibniz-Institut für Mikroelektronik)

June 2019-June 2023

Website: [5g-victori-project.eu](https://www.5g-victori-project.eu)

Twitter: @5gvictori

### Objectives

5GVICTORI performs large-scale trials in real operational environments where services related to Transportation, Energy, Media and Factories of the Future are integrated in an open 5G ecosystem<sup>15</sup>. This ecosystem integrates commercially relevant, operational vertical infrastructures together with interconnected 5G facilities across Europe (3 ICT-17 facilities plus 5GUK)<sup>16</sup>. This demands a flexible architectural framework able to address a wide range of vertical applications, offer converged services across heterogeneous technology domains and have a unified software deployment<sup>17</sup>. Several service blueprints have been developed and exposed to the 5GVICTORI ecosystem through a common framework. The trials carried out over the interconnected facilities are assessed adopting a unified monitoring and evaluation methodology and in accordance with a set of technology and business KPIs.

### Major results and innovations

The 5G-VICTORI multi-domain orchestration brokering platform (5G-VIOS)<sup>18</sup>, illustrated in Figure 7, allows brokering of experimentation procedures and orchestration of resources of individual facilities through interaction with the individual facility orchestrators. Overall, 5G-VIOS enables management of slices, and orchestration of end-to-end (E2E) vertical net-

work services across multiple domains and facilitates integration of the components required for the demonstration of Vertical and cross-Vertical services. 5G-VIOS has been successfully deployed in two (out of four) facilities, enabling practical infrastructure sharing through slicing and virtualisation.

### Description of demos, trials and use cases

In 2022, the 5GVICTORI project had already completed the first cycle of trials and KPI evaluation for all facilities and had demonstrated its capabilities and the relevant Use Cases (UCs) in the 5G-EVE based deployment in Alba Iulia, Romania, and in the 5GUK testbed deployment in Bristol, UK<sup>19</sup>. Six industry-driven UCs have been selected for trials over the 5G-VICTORI Platform and are summarised below.

- **“Enhanced Mobile broadband under high-speed mobility”: Transportation – Rail.** The goal of this UC is to demonstrate eMBB functionality in operational railway environments. To that end, innovative technologies for trackside to train and train to core interconnection have been deployed and assessed towards the verification of FRMCS stringent performance KPIs (final demonstrations to be performed in the second half of 2023). The first field trials took place in 2022 and they were successful in integrating a variety of 3GPP and non 3GPP technologies and validating connectivity and extension of the infrastructure in real rail environment in the city centre of Patras. In addition, the project has developed and already tested new handover management functions with the aim to preserve network sessions across heterogeneous networks as trains move.

15. 5GVICTORI deliverable D2.1, “5GVICTORI Use case and requirements definition and reference architecture for vertical services”, March 2020, [https://www.5g-victori-project.eu/wp-content/uploads/2020/06/2020-03-31-5GVICTORI\\_D2.1\\_v1.0.pdf](https://www.5g-victori-project.eu/wp-content/uploads/2020/06/2020-03-31-5GVICTORI_D2.1_v1.0.pdf)

16. 5GVICTORI deliverable D2.3, “Final individual site facility planning”, June 2021, [https://www.5g-victori-project.eu/wp-content/uploads/2021/07/2021-06-11-5G-VICTORI\\_Deliverable\\_D23\\_v1.0\\_submitted\\_EC.pdf](https://www.5g-victori-project.eu/wp-content/uploads/2021/07/2021-06-11-5G-VICTORI_Deliverable_D23_v1.0_submitted_EC.pdf)

17. 5G-VICTORI deliverable D2.4, “5G-VICTORI end-to-end reference architecture”, April 2022, <https://www.5g-victori-project.eu/wp-content/uploads/2022/05/2022-04-11-D2.4-5G-VICTORI-end-to-end-reference-architecture.pdf>

18. 5G-VICTORI deliverable D2.6, “5G-VICTORI Infrastructure Operating System – Final Design Specification”, January 2022, <https://www.5g-victori-project.eu/wp-content/uploads/2022/02/2022-01-31-D2.6-5G-VICTORI-Infrastructure-Operating-System-%E2%80%93-Final-Design-Specification.pdf>

19. 5G-VICTORI deliverable D4.2, “Intra-Field trials integration and vertical services execution and KPI validation”, March 2022, <https://www.5g-victori-project.eu/project-outcomes/deliverables/>

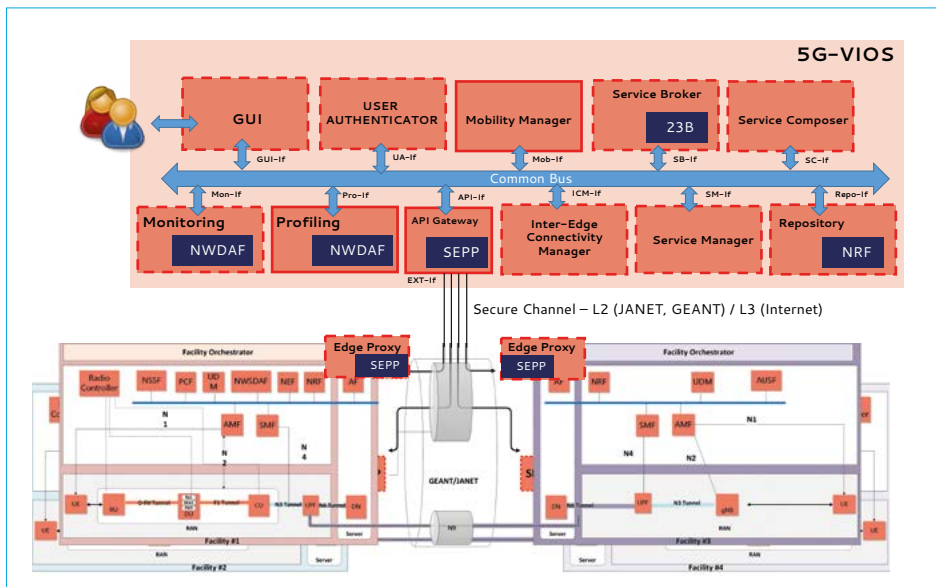

Fig. 7: 5G-VICTORI E2E Reference Architecture

- **“Digital Mobility”: Transportation and Media.** The 5G-VICTORI “Digital Mobility” UC family includes innovative mobility applications to be showcased in Berlin and Bristol: 1) synchronous 360° video tour guide for travellers in a smart city; 2) 360° VR Multicamera Live stream for large scale user connectivity attending real-time classes via VR; 3) passengers’ guidance with multi-modal transport journey planning while on the move. In 2022, the provision of infotainment services and public safety critical services was validated and demonstrated in the operational buses at Alba Iulia Municipality (Romania). These services include display of public information via a Captive portal and TV services, and the identification of emergency situations using Artificial Intelligence algorithms. In addition, the provisioning of 360° VR Multicamera Live stream service over multiple caches – multiple edge deployment was demonstrated in various locations of the Bristol, UK (5GUK) facility. Finally, the passengers’ guidance with multi-modal transport journey planning service was successfully trialed in both Bristol and Berlin 5G-VICTORI sites, focusing on the capability to perform rendering of high complex photo-realistic 3D scenes (with high reliability and

ultra-low latency requirements) on the Edge of the 5G Network.

- **“Critical services for railway systems”: Rail.** This UC aims to showcase an infrastructure capable to fulfil the stringent performance, safety, and security requirements of the future needs of both rail signalling systems (on-board and ground) and 3GPP Mission Critical (MC/ MCX) based Future Railway Mobile Communication Systems (FRMCS) services. Rail Critical Services include Rail signalling, CCTV monitoring, Telephony (Cab Voice and Emergency Calls), MC Push-To-Talk, and Sensor data. In 2022, Rail Signalling, Closed-Circuit Television (CCTV) monitoring and Dispatcher services were tested in a lab environment and their operation was validated under various traffic conditions. Some of these services were successfully tested in an operational railway environment.
- **“Smart Energy Metering”: Energy and Rail.** The UC focuses on the provisioning of different energy metering services for Low Voltage (LV) distribution grids in cities and High Voltage (HV) transmission grids, supporting industrial clients, over integrated 5G infrastructures. In 2022, the LV scenario was deployed and demonstrated in the Orange Romania

facility lab and in the operational smart city environment of Alba Iulia. The demonstration focused on energy metering data collection from endpoints across Alba Iulia and their transfer to the telemetry platform in the cloud, via 5G Massive Machine Type Communications (mMTC). The Alba Iulia Municipality has validated the performance and the functionality of the implemented UC scenarios, highlighting the LV results for energy metering, pro-active management and automatic alarming system in case of issues.

- The HV scenario constitutes a cross-vertical UC, comprising vertical services with stringent performance requirements namely: smart energy metering in railways (railway vertical service), as well as real-time power consumption information exchange between an HV substation and an electric train (energy vertical service) to be delivered over a 5G Non-Public-Network (NPN) deployment. For the deployment and evaluation of the simultaneous provisioning of two stringent applications, the first testing phases took place in a lab setup. Lab testing proved that the proposed 5G deployment meets the FRMCS strict performance requirements for exchange and correlation of synchronised measurements and facilitate power quality improvement and cost reduction for both Railway and Transmission System Operators.

- **“Digitisation of Power Plants”: Smart Factory.** This UC concentrates on an advanced monitoring solution aiming at simultaneously supporting different smart factory services (preventive maintenance, security, monitoring of critical infrastructure), through a 5G NPN. The solution involves a scalable platform able to collect and analyse measurements from newly established and legacy sensors, spread across two different sites. To this end, several different components (legacy sensors, 5G NPN, vertical applications, etc.) were successfully integrated in an operational, HV industrial vertical environment, extending the Patras 5G-VINNI leg of the 5G-VICTORI deployment. Key lessons include the identification of critical challenges related to the collocated deployment of communication and HV equipment.

- **“CDN services in dense, static and mobile environments”:** **Media.** This UC involves integration of multi-level Content Delivery Network (CDN) platforms with private 5G network deployments, using mmWave, edge computing capabilities, and edge caching on-board the train. Multi-CDNs capabilities are enabled via “Data Showers” installed at selected locations (Berlin Central station, Patras train facilities) along the train route. Initial testing activities have validated the applicability of such extensions to the railway environment, taking under consideration the time trains reside/ wait at platforms, the number of stations between platforms, the Video on Demand (VoD) as well as semi-real time TV streaming service requirements, the train capacities, etc. Moreover, 360° cameras based remote surveillance services were also initially tested in the lab environment prior to deployment at the railway infrastructure.

#### Vertical use cases addressed in 5G PPP

**Energy, Industry 4.0, Media and Entertainment, Transport and logistics**

# 5G PPP PHASE 3, PART 4: 5G LONG TERM EVOLUTION

The eight Projects<sup>20</sup> retained by the EC in response to the 5G PPP ICT-20-2019 call started

in November 2019. Some of them were awarded deadline extensions due to Covid-19.

20. <https://5g-ppp.eu/5g-ppp-phase-3-4-projects/>

## ARIADNE

### Artificial Intelligence Aided D-band Network for 5G Long Term Evolution

Coordinated by Halid Hrasnica (Eurescom)

November 2019-February 2023

Website: [ict-ariadne.eu](http://ict-ariadne.eu)

Twitter: @ict-ARIADNE

#### Vision, System Concept, and Findings

The ARIADNE project has been working on enabling spectral-efficient, high-bandwidth, intelligent wireless communications by developing three complementary, critical new technologies for 5G networks:

- New radio technologies for communications above 100 GHz D-Band frequency range
- Advanced connectivity based on reconfigurable intelligent metasurfaces
- Machine Learning and Artificial Intelligence techniques for management of high-frequency communications resources and reconfiguration of the metasurfaces.

ARIADNE aspires to transform the current 5G wireless thinking from focusing on “local” network improvements to realising a longer-term vision of pervasive mobile virtual services. The project brought together a novel, high-frequency advanced radio architecture and an Artificial Intelligence (AI) network processing and management approach in a unified system beyond 5G concept. The ARIADNE has investigated, theoretically analysed, designed, developed, and showcased in a proof-of-concept demonstrator an innovative wireless communications concept addressing networks beyond

5G. In this concept, ultra-high spectral-efficient and reliable communications in the D-band can be dynamically established and reconfigured by Machine Learning (ML)-based design and intelligent network management, in both “Line of Sight” (LoS) and “Non-Line of Sight” (NLoS) environments.

#### D-Band communications link

High frequency systems, such as D-band, suffer from large path losses requiring utilisation of high gain antennas, where – if line-of-sight is available – traditional beamforming at the transmitter and receiver sides can help with mitigating the channel losses and providing the ability for tracking mobile users. Due to the decreasing electric size of antennas as a function of frequency, D-band suffers from high path losses, even on the LOS path. Therefore, high-gain antennas have to be used to compensate the losses while also allowing multiple-input multiple-output (MIMO) communications by applying beam steering.

In practice, the antennas are not always stationary, even in static backhaul/fronthaul configurations, e.g., due to environmental effects such as wind, small structure deformation, or stochastic tracking estimation errors. This is not a major problem at lower frequencies, but the D-band

high-gain antennas are very sensitive to mis-alignment. This causes a need for accurate and efficient channel estimation to constantly update the beamformers to minimize beam misalignment and maintain sufficient link conditions.

### **Advanced connectivity – Communication Theory framework beyond Shannon**

In non-line-of-sight situations, the D-band systems can benefit by applying Reconfigurable Intelligent Surfaces (RIS), allowing intelligent manipulation of radio propagation towards the mobile user as required. An important aspect of ARIADNE is to explore radio propagation via RISs that are expected to significantly increase the received signal power in NLOS situations where the LOS path is blocked. During its lifetime, the ARIADNE project investigated various aspects of application of the Reconfigurable Intelligent meta-Surfaces (RIS) in future beyond 5G wireless telecommunications networks. The project considered channel modelling issues related to the RIS application, established a new corresponding framework “beyond Shannon” to characterize RIS aided networks, investigated application of Artificial Intelligence and Machine Learning enabling control of such complex systems as well as proper positioning of the RIS elements across network coverage areas, and much more. Here, the RIS implementation provides a possibility to modify the propagation environment and differently from the conventional networking approach, to consider the environment as a dynamic variable, in order to provide good signal quality also in NLOS situations.

### **Management of high-frequency communications resources by ML & AI**

Future wireless networks 5G and beyond 5G (B5G) are expected to meet the massive demand for data rates especially for the extended reality (XR), augmented reality (AR) and mixed reality (MR). In order to meet the various requirements, the future new radio not only considers the sub-6 GHz but also takes millimetre-wave (mmWave) band and terahertz (THz) band into implementation. In most of the actual wireless communication scenarios, it is impossible to keep users (UEs) from moving. Therefore, the base stations (BSs) need to have effective mechanism to allocate proper beamforming vector to the

moving UEs. This leads to our concern to address this research work to make the UEs real time interaction with the environment easy using deep reinforcement learning (DRL).

In general, the system capacity of wireless communications is represented by the weighted sum rate when the UEs have different priority and require different capacity. The summation of the achievable rate of all UEs can be also the overall throughput representation of the network. We consider single agent DRL and multi-agent DRL when multiple cells coordinate with each other to serve UEs. With deployment of beam selection based DRL in both single-agent and multi-agent, the main component is the environment where the training happens real-time while a multi-agent environment has multiple acting entities per step.

Furthermore, resource allocation among UEs to Aps becomes challenging in case of connection blockages preventing the LoS connections because adjusting the entire communications in an area to such blocked links is a very complex and difficult to solve by applying classic modelling approaches. The proposed solution is a “Hybrid Metaheuristic-Machine Learning” framework that leverages an online Metaheuristics solver to traverse the exponentially large state space of possible UE-AP combinations, where the system model of the environment can be changed on-the-fly and the solution adapts in real time.

### **Major results and innovations**

#### **Point-to-Point D-Band demonstrator**

The demonstrator will include a Point-to-Point Line of Sight (LoS) link at D-band, using the hardware developed within the framework of the ARIADNE project (Figure 8). It consists of a baseband unit (BBU), which includes two modems responsible for the horizontal and vertical polarisations respectively, two DAC/ADC (Digital to Analog Converter/Analog to Digital Converter) boards each for the generation/reception of data, radio frequency (RF) front-ends for the up and down conversion in the D-band, as well as two Cassegrain antennas for the outdoor testing. The link will be set up between the rooftops of two buildings at Intracom Telecom premises, in Athens, Greece, and the link distance will be approximately 200 meters.

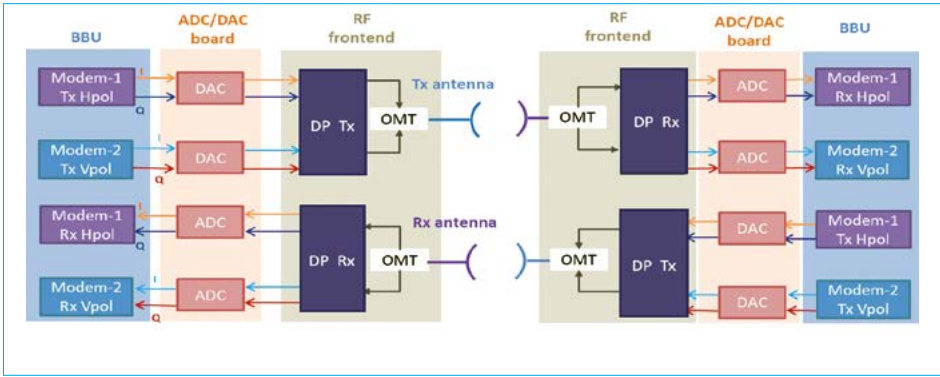

Fig. 8: ARIADNE Point-to-Point D-Band demonstrator architecture

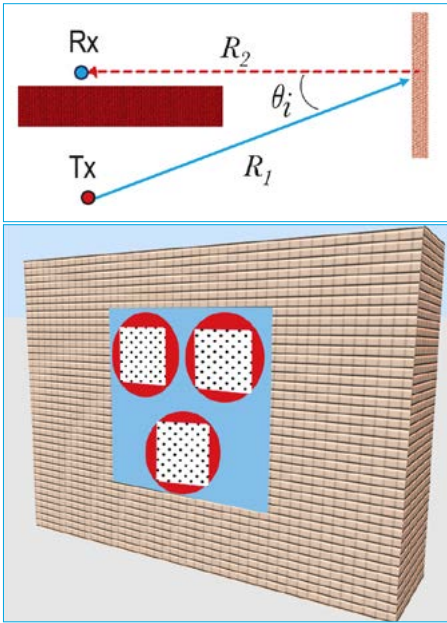

Fig. 9: RIS / Metasurfaces demonstration scenario

### Reconfigurable Intelligent Surfaces in Indoor / office scenario

This demonstrator shows a possibility to use anomalously reflecting metasurfaces to direct millimetre-band waves towards receivers in the shadow of a wall (Figure 9). In the scope of the ARIADNE project, we designed and manufactured three metasurface samples for three frequency bands that can be positioned in a “collage” way on the wall, so that each of the surfaces acts at its designated band.

First, an analytical model of wave propagation in the presence of anomalously reflecting metasurfaces has been developed and used to estimate the required metasurface size for the required distance between the transmitter and receiver. Next, a new method for fast and efficient design of anomalous reflectors has been created, to design and manufacture the required samples for the demonstrator. Finally, the entire setup was tested at Fraunhofer Institute, achieving quite promising results.

#### References

- S. Kosulnikov, C. S. Francisco, X. Wang, and S. Tretyakov, Simple link-budget estimation formulas for channels including anomalous reflectors (<https://doi.org/10.36227/techrxiv.21685043.v1>, 2022)
- S. Kosulnikov, X. Wang, S. A. Tretyakov, Discrete impedance metasurfaces for 6G wireless communications in D-band, (<https://arxiv.org/abs/2302.07313>, 2023)

## Beyond 5G multi-tenant private networks integrating Cellular, Wi-Fi, and LiFi, Powered by Artificial Intelligence and Intent Based Policy

Coordinated by Jesus Gutierrez Teran  
(IHP Leibniz-Institut für Mikroelektronik)  
November 2019-February 2023  
Website: [5gclarity.com](http://5gclarity.com)  
Twitter: @5G\_CLARITY

5G-CLARITY brings forward the design of a system for beyond 5G private networks by addressing the main challenges in this area.

The emergence of private networks guarantees the delivery of voice, text, data and video, and connection to machines, sensors, devices, and computing systems, as well as people in the privately owned venues and enterprises. So much as popular the private networks are within the industry and research communities, their widespread adoption will only become a reality if their operational costs are small, and a seamless interworking between 5G access and other industry technologies (e.g., wired Ethernet, Wi-Fi and emerging technologies such as LiFi) is made possible. Among the technical challenges, spectrum management, multi-WAT (multiple wireless access technologies) and multi-tenancy support, software defined networking (SDN) and network function virtualisation (NFV) powered infrastructure slicing, and data-driven network management could be named as outstanding.

5G-CLARITY proposed architecture (presented in previous Annual 5G Journal editions) can be found in the 5G-CLARITY D2.1<sup>21</sup> and D2.2<sup>22</sup> available on the project's website. During the last period of the project, the Infrastructure Stratum architecture and the Network Function and Application Stratum were finalised, and specifications of the non-public network (NPN) use cases in the scope of 5G-CLARITY were identified. On these bases, the final 5G-CLARITY architecture is evaluated, and the results are reported in 5G-CLARITY D2.4<sup>23</sup>. For the Management and Orchestration Stratum,

the initial design for the Slice Manager and the multi-WAT non-real time RAN intelligent controller (RIC) are provided, and a subsystem to gather multi-WAT telemetry in a RIC is designed for which the main components are the Data Semantics Fabric. This can be used to gather and manipulate streaming data from multiple sources in the network, and the Data Lake that makes data available to the ML models living in the Intelligence Stratum. For the Intelligence Stratum, a set of nine distinct ML models are identified that can be used to optimise network performance, including both non-real-time and near-real-time optimisation. An AI-engine is defined as a containerised execution environment that can manage the lifecycle of ML models. Moreover, an intent-based networking for facilitating customer interaction in private networks is devised, and a set of eight use cases are identified to illustrate the use of the intent-engine within the 5G-CLARITY system, e.g., interactions between the network operator and the intent-engine, and between individual ML models and the intent-engine.

### Major results and innovations

The project's results on the final evaluations of the proposed *spectrum sharing framework using citizens broadband radio service (CBRS), Multi-connectivity and 5G-CLARITY eAT3S framework, advanced resource management framework, multi-wireless-technology positioning framework, and the integrated 5G NR/Wi-Fi/LiFi network performance*, are discussed in 5G-CLARITY D3.3<sup>24</sup>.

The evaluation of the end-to-end 5G Infrastructure and Service Slices and the evaluation of the developed self-learning ML algorithms proposed and designed in the project

21. [https://www.5gclarity.com/wp-content/uploads/2020/06/5G-CLARITY\\_D2.1.pdf](https://www.5gclarity.com/wp-content/uploads/2020/06/5G-CLARITY_D2.1.pdf)

22. [https://www.5gclarity.com/wp-content/uploads/2020/12/5G-CLARITY\\_D2.2.pdf](https://www.5gclarity.com/wp-content/uploads/2020/12/5G-CLARITY_D2.2.pdf)

23. <https://www.5gclarity.com/wp-content/uploads/2023/03/5G-CLARITY-D24-Amended.pdf>

24. <https://www.5gclarity.com/wp-content/uploads/2023/03/5G-CLARITY-D33-Amended.pdf>



are performed and reported in 5G-CLARITY D4.3<sup>25</sup>. These are achieved through the final implementation of the 5G-CLARITY Service and Slice Provisioning System with an experimental demonstration of intent-driven Slice as a Service capabilities. The implementation and integration of the data management and processing subsystems are validated through a Proof-of-Concept experimental scenario. The self-learning ML algorithms are validated through execution in several scenarios, providing a variety of network functionalities to the system. These two aspects are presented in an integrated experiment showcasing the coordination of ML models within the AI Engine, fed by data accessible through the Data Lake and the results exposed through communication with the Intent Engine.

Private-public network integration is one of the main distinguished features of the 5G-CLARITY system. This feature represents the ability to make 5G-CLARITY capabilities interwork with MNO's managed capabilities seamlessly. This deliverable reports on relevant application scenarios related to enablers such as the Mediation Function and Service Delivery Models. The final solution design of the Mediation Function is showcased in a use-case based approach highlighting the applicability in a private-public network environment. Service Delivery Models are presented in two scenarios, these are NFVI as a Service and Slice as a Service. These scenarios are presented through two distinct use cases. These include the instantiation of a NFVI in a Smart Internet Lab environment and the provisioning of a network slice through an intent-based interface informed by smart models.

5G-CLARITY features two pilots and three use cases, namely the Smart Tourism pilot, implemented in M-Shed Museum in Bristol as:

- UC1: "Enabling Enhanced Human-Robot interaction", demonstrated on February 20, 2023, at M-Shed Museum, Bristol, UK; and the Smart Factory pilot, implemented as:
- UC2.1: "5G-CLARITY infrastructure slicing supporting Industry 4.0 services", and
- UC2.2: "Enhanced AGV positioning for intralogistics", demonstrated on November 24, 2022 in the Bosch factory in Aranjuez. The main goal of demonstrated use cases is to validate 5G-CLARITY technical innovations in the following areas:
- 5G-CLARITY multi-connectivity framework, integrating 5G, Wi-Fi, and LiFi technologies
- AI-driven, intent-based network management and slice provisioning
- Enhanced localisation using multiple wireless technology localisation framework

The demonstrations show the benefits and challenges of setting up a beyond 5G multi-tenant private network, with specific measured KPIs as,

- Production data traffic delays/latency experienced in a real Industry 4.0 scenario,
- Production data traffic packet throughput in a multi-wireless-access-technology (multi-WAT) setup in real Industry 4.0 scenarios,
- Multi-access technology handover in real Industry 4.0, and real public museum environment,
- Intent-based network management and slice provisioning,
- Multi-technology localisation accuracy in a real Industry 4.0 scenario.

Figure 10 shows the architecture for the trials, as well as the photos from the real measurement's campaigns.

25. <https://www.5gclarity.com/wp-content/uploads/2023/03/5G-CLARITY-D43-Amended.pdf>





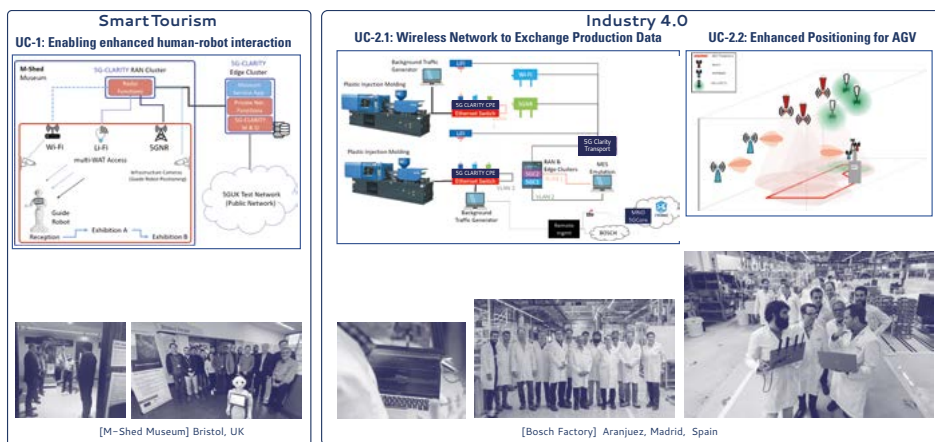

Fig. 10: 5G-CLARITY Trials at Bosch Plants, Madrid, Spain; and MShed Museum, Bristol, UK

### Vertical use cases addressed in 5G PPP

**Industry 4.0, Smart cities and utilities, Tourism**

## 5G-COMPLETE

**A unified network, computational and storage resource management framework targeting end-to-end performance optimisation for secure 5G multi-technology and multi-tenancy environments.**

Coordinated by Hercules Avramopoulos (ICCS/NTUA)

November 2019-October 2022

Website: [www.5gcomplete.eu](http://www.5gcomplete.eu)

Twitter: @5gcomplete

### 5G-COMPLETE approach

The 5G-COMPLETE project proposes an architectural approach inspired by state-of-the-art standardisation activities pursued by ETSI, 3GPP, IEEE and the Open-RAN (O-RAN) alliance, that efficiently integrates a variety of advanced wireless technologies including digital and analogue transport schemes as well as mmWave and THz solutions with optical and packet networking to support the required network connectivity for 5G. In addition, 5G-COMPLETE proposes full integration of network with compute and storage resources in support of the very demanding current and upcoming 5G services. The architectural

principles of 5G-COMPLETE exploit the benefits of softwarisation migrating from the notion of network elements to network functions, the separation of user plane and control plane and Radio Access Network (RAN) disaggregation. RAN disaggregation refers to functional decomposition of the RAN baseband processing functions, corresponding to the relevant protocol-layer stack, to a set of functions that can be processed independently at the Remote, the Distributed and Central Units (RUs, DUs, CUs), placed either at one or more locations supporting a variety of functional splits. Another architectural principle



of 5G-COMPLETE relates with the adoption of cloud computing in support of the processing requirements of the various Fronthaul (FH) and Backhaul (BH) services the solution will support. The proposed approach introduces flexibility in the way compute resources are allocated across the 5G-COMPLETE infrastructure as it allows both integration of a central cloud solution as well as more distributed approaches where smaller scale compute and storage resources are placed at the network edge closer to the end user in accordance with the Mobile Edge Computing (MEC) paradigm. MEC will play a key role in order to further guarantee the capability of the 5G-COMPLETE solution to support demanding requirements associated with reduced end-to-end latency and transport network capacity.

### 5G-COMPLETE Functional Connectivity

5G-COMPLETE project adopts a flexible architectural approach that allows integration of

a variety of technologies able to support many different telecom and vertical industries related use cases and services with very different requirements and characteristics. These include transport network technologies such as advanced wireless networks and optical as well as packet transport network solutions integrating compute and storage resources in line with the MEC and Central Cloud approaches. The different 5G NR deployment options supported by the project along with the technologies used to implement these, are summarised in Figure 11. These options combined can be used to provide any service with highly variable Key Performance Indicators (KPIs) for Ultra-Reliable LowLatency Communication (URLLC), Massive Machine-Type Communication (mMTC) and enhanced Mobile Broadband (eMBB) services.

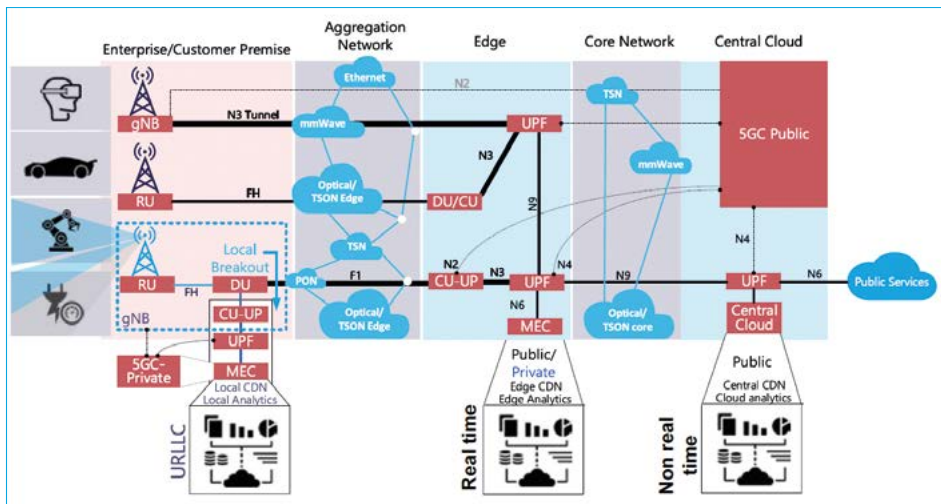

Fig. 11: 5G-Complete deployment options

### Description of demos and/or trials

All systems and components developed within the 5G-COMPLETE project will be demonstrated at several lab-scale and live field-trial demonstrators. The different demonstrators are being prepared in extended testbeds located at Athens, Lannion and Bristol, utilising the laboratory facilities of IASA/NKUA, ICCS/NTUA and

Bristol’s universities, as well MO’s infrastructure provided by Cosmote and Orange.

The first lab-scale demonstrator of 5G-COMPLETE was conducted on July 11, 2022, in the laboratory premises of IASA, located at Athens, Greece. The objective of this demo was to evaluate the 5G-COMPLETE architecture in a lab scale environment through the

end-to-end provisioning of infrastructure slices supporting smart energy metering services.

Two additional Live demonstrations will be held in Lannion and Bristol:

- The demo that will be hosted in Orange's facilities in Lannion, will be performed over a converged architecture, involving several types of physical connections, physical and virtual resources as well as 5GRAN deployment options. The performance of multi-technology transport network will be assessed under realistic traffic flows provided through a virtualised 5GRAN solution comprising vCU/ vDU/vRU. From an application point of view, the demonstration will permit to evaluate the transmission of the interfaces connecting the different equipment items of a mobile network. It will also permit to validate that the optical network infrastructure can cope with the needs of the mobile users.

- The 5G-COMPLETE project's final demonstration will be held in Bristol 5G UK Testbed. University of Bristol will develop a 5G-COMPLETE network integrating its technologies within the 5GUK test network and will create service slices to demonstrate a set of 5G-COMPLETE Use Cases. The deployment of 5G-COMPLETE technologies includes among others: Open RAN deployment of a 5G cellular network, a mix of access connectivity using wired and wireless solutions in licensed and unlicensed bands for the service delivery, fibre network connectivity across the city of Bristol, Time shared optical network (TSON) demonstrating high capacity and flexible optical transport connectivity between two sites in the city of Bristol, central cloud services, MEC technologies and an NFV Orchestration framework.

#### Vertical use cases addressed in 5G PPP

Public safety, Smart cities and utilities

## INSPIRE-5Gplus

### INSPIRE-5Gplus: Intelligent Security and Pervasive Trust for 5G and Beyond.

*Coordinated by Uwe Herzog (Eurescom)*

*November 2019-October 2022*

*Website: [www.inspire-5gplus.eu](http://www.inspire-5gplus.eu)*

*Twitter: [@inspire\\_5gplus](https://twitter.com/inspire_5gplus)*

#### Objectives

INSPIRE-5Gplus aims to advance 5G security and devise a smart, trustworthy, and liability-aware 5G security platform for future connected systems. This vision is facilitated with the exploitation of Zero-Touch Service and Network Management (ZSM), Software-Defined Security (SD-SEC), Artificial Intelligence/Machine Learning (AI/ML) techniques, Moving Target Defence (MTD), PoT (Proof of Transit), blockchains and Trusted Execution Environment (TEE). A comprehensive set of novel security assets were developed to address some known challenges, e.g., adaptive slice security, and new ones like proactive security integrated into a high-level security architecture (HLA) developed by the project. Security-wise contributions were accompanied by the second research pillar of the project, namely trust and

liability, through integration of novel mechanisms supporting confidence between parties and compliance with regulation.

#### Major results and innovations

INSPIRE-5Gplus achieved the following main outcomes and innovations during its execution:

- INSPIRE-5Gplus designed and implemented a **closed-loop and automated end-to-end smart network and service security management framework** that empowers not only protection but also trustworthiness and liability in management of 5G network infrastructures across multiple domains. This goal was achieved while ensuring that the provided security is compliant with the expected Security Service Level Agreement (SSLA) and the regulation requirements.



- **Intelligent and autonomic end-to-end cybersecurity services** that can detect and mitigate existing and new threats targeting 5G networks were developed. These assets operate following a Zero-touch network and Service Management (ZSM) paradigm to provide a software-defined security orchestration and management that enforces and controls security policies of network resources and services.
- **Evolved and new security assets using novel tools and techniques with a focus on trust and liability across 5G infrastructure and services:** Liability-related metrics and KPIs which can be used to create a closed loop for liability-management have been defined. We investigated how Root Cause Analysis (RCA), Deep Attestation, novel software hardening and monitoring techniques and these liability metrics can be used to enhance each other.
- **A comprehensive analysis of the current security landscape of 5G networks,** and the foreseen evolution trends of this landscape regarding security threats and security requirements was generated.
- **An integration and experimentation framework and three demonstrators** aiming to validate specific 5G security use cases were created. To maximize the synergy between the partners and their assets, it was essential to deploy this joint testing infrastructure.

More than 60 technical publications in scholarly journals and international conferences, 3 submitted patent applications and 17 open-source assets were realised during the project period. Please see the project website<sup>26</sup> for further details. The results obtained were validated and tested in selected demonstration scenarios described in the following section.

### Description of demos and/or trials

INSPIRE-5Gplus have developed **three main demonstrators based on the developed assets and investigated use cases.** These demonstrators have showcased that INSPIRE-5Gplus has completed its objective: to provide a zero-touch security framework made from advanced enabling technologies, e.g., emerging AI techniques, ZSM, TEE, MTD, considering the requirements of advanced 5G use cases. More specifically, the feasibility of the HLA was

demonstrated in complex scenarios that delivered a high-end security framework combining multiple enablers developed in INSPIRE-5Gplus with an extensive range of features. An implementation of each demonstrator with validated KPIs was also delivered at the end of the project.

### Demo1 – Security Management Closed Loop

This demo shown in Figure 12 focused on the technical challenges due to complexity of the network heterogeneity, lack of common understanding on security agreements and impact in 5G network slice adoption. The demonstrated solution declares SSLAs and enforces them over heterogeneous domains and tools with common a policy language (MSPL-OP) and provides standard common framework based on ETSI ZSM and closed-loop mitigation. It also incorporates native support for security in network slicing and provides a modular approach based on drivers and plugins.

From the business perspective, the demo proposed a joint exploitation for a management system to guarantee specific Security SLAs of different slices and envisaged a minimum valuable product with INSPIRE-5Gplus enablers. It achieved the instantiation of the INSPIRE-5Gplus HLA integrating more than 20 Security Enablers in an E2E Security Management Domain (SMD) and 5 SMDs.

Demo1 showcased two scenarios, namely, proactive and reactive. In the former, two network slices with specific SSLAs from a 5G network customer are considered. The SSLA instantiation generates 5G Security Slices with sub-slices composed of services and associated security in different domains and continuously monitor the security requirements.

In the latter, reactive mitigation to compromised requirements are performed. Different kind of attacks including crypto-mining, DDoS and cipher suite violation are considered. Different SMD and E2E SMD mitigations are enforced for the same threat according to the SMD capabilities.

One of the attacks developed in Demo1 was included as an ENI use case and published on ETSI Whitepaper n°44. Also, a PoC was submitted to the *ETSI ZSM #19* meeting<sup>27</sup>, and was

26. <https://www.inspire-5gplus.eu/>

27. [https://zsmwiki.etsi.org/index.php?title=PoC\\_6\\_Security\\_SLA\\_assurance\\_in\\_5G\\_network\\_slices](https://zsmwiki.etsi.org/index.php?title=PoC_6_Security_SLA_assurance_in_5G_network_slices)

publicly shown in a booth as part of the *ETSI Security Conference* in Oct. 2022 in the ETSI

Headquarters. A video of demo 1 can be found on the *INSPIRE-5Gplus* web.

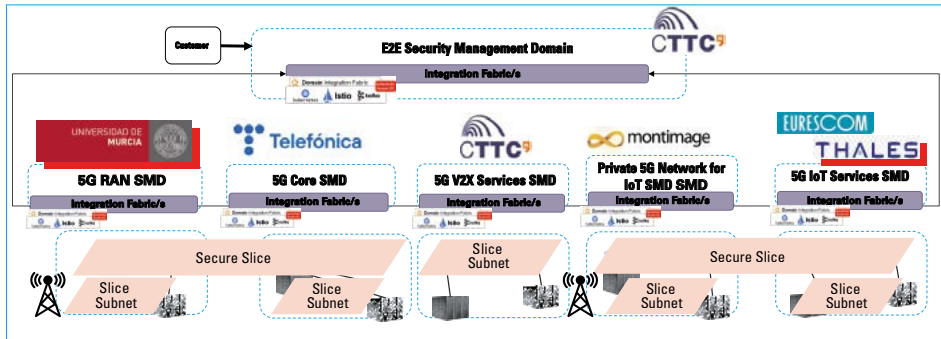

Fig. 12: Demo 1 enablers and architecture

### Demo2 – Trust and Liability Management

Demo2 relates to Liability mechanisms between several stakeholders in a 5G network and focuses on an industrial use case (with an IoT Campus operated at MONTIMAGE’s office). An industrial entity subject to safety constraints (due to its applicable regulation such as SEVESO Directive

for Chemical Industry) must collect assurances on the operational isolation of its software components in case of crisis. This demo shown in Figure 13 illustrates vertical SLA deployment through several specific commitments of a vertical service isolation over the deployed infrastructure and demonstrates the fulfilment / effectiveness of isolation as committed.

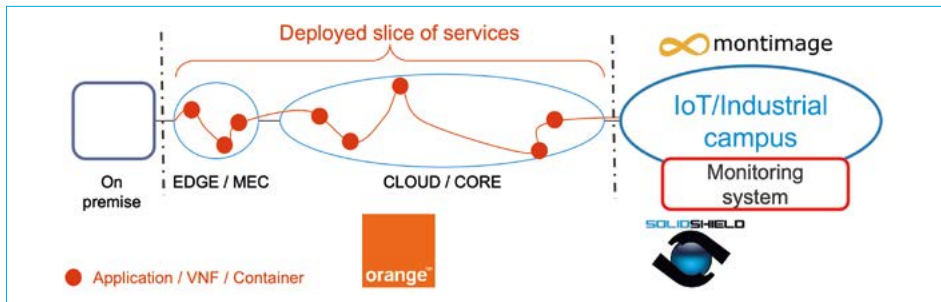

Fig. 13: Demo 2 architecture and network domain

Demo2’s objectives are 1) to demonstrate how two different legal entities reach a mutual commitment on a service / SLA, through a pre-agreed way to control it (the proof convention) 2) to reveal and exemplify evidences of SLA effectiveness, and 3) to demonstrate how an industrial entity (i.e., the client) can investigate, on demand, beyond the point of connection to the infrastructure (IT / Network).

This demo was also presented at the Orange “Salon de la Recherche et de l’Innovation” event which was held between in October 2022 in Chatillon, France.

### Demo 3 – Moving Target Defence (MTD)

The objective of this demonstrator shown in Figure 14 is the evaluation of MTD as an effective mechanism in improving the network’s

resilience against attacks by effectively protecting network slices through dynamic reconfiguration of 5G infrastructure properties. Essentially, it highlights the security, functional and non-functional requirements, as well as the services of the INSPIRE-5Gplus HLA (high Level Architecture) that enable the proactive security of the underlying infrastructure. The focus of the demo is the proactive change of the slice configuration and VNF deployed instances to alter the attack surface and impede pre-attack reconnaissance advantages of attackers prior to the attack stage. The cooperation of the MTD

Controller and the Slice Manager enablers is mainly based on network slice monitoring, especially of critical slices that will trigger their reconfiguration proactively and reactively based on a defined threat and cost model. The MTD mechanisms deployed should be adapted corresponding to the threat under consideration, ranging from no action to simple indirection or even multiple stacked indirections. The levels of MTD actions applied consider the end-user cost of applying the action in order to avoid penalising legitimate users and make progressively the path to the protected resources more complex.

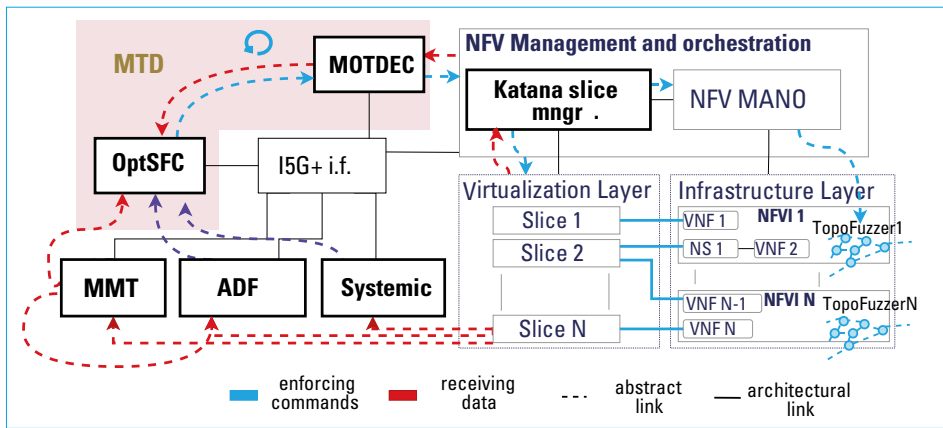

Fig. 14. Demo 3 architecture

In addition, MTD can protect security functions in a slice to maintain their configuration and software runtime integrity and increase their robustness against reconnaissance and advanced persistent threats (APT). An important aspect of Demo 3 is the collection and joint analysis of heterogeneous data from points of interest within the 5G infrastructure for integrated monitoring. Security Agents act as distributed probes that will be deployed on-the-fly and adapted to changing requirements and topology. These probes extract data from packets, flows, system and applications logs that will be subsequently used by the Security Analytics Engine and the MTD mechanism.

The demo enablers leverage Artificial Intelligence (AI) for detection and mitigation of attacks. A real-time model of the 5G network state into

a Multi-Objective Markov Decision Process (MOMDP) is constructed which takes into account resource consumption, security and Quality of Service (QoS) dimensions as part of a trade-off problem. It trains a deep RL agent interacting with the MOMDP and finds the optimal MTD strategy for maximising security gains while minimising the resource and QoS burden.

Demo3 is deployed onto the 5GENESIS testbed at NCSR in Athens, Greece and runs in that environment enabling enhanced prevention and efficiency with State of the Art AI/ML techniques while following a closed-loop management approach for security automation.

#### Vertical use cases addressed in 5G PPP

**Automotive, Industry 4.0, Smart cities and utilities, Transport and logistics**

## LOCalisation and analytics on-demand embedded in the 5G ecosystem for Ubiquitous vertical applicationS

Coordinated by Nicola Blefari Melazzi (CNIT)

November 2019–October 2022

Twitter: @H2020Locus

Website: [www.locus-project.eu](http://www.locus-project.eu)

### Objectives

LOCUS is improving the functionality of 5G infrastructures to: i) provide accurate and ubiquitous location information as a network-native service; ii) derive more complex features and behavioural patterns out of raw location and physical events; and iii) expose them to applications via simple interfaces. Localisation, together with analytics, and their combined provision “as a service”, will greatly increase the overall value of the 5G ecosystem, allowing network operators to better manage their networks and to dramatically expand the range of offered applications and services. The current freedom to act on 5G system design (and beyond 5G systems) and availability of software network paradigms and AI techniques uniquely combine in this historical moment to make it possible to radically improve the future network by endowing it with accurate on-demand localisation and analytics.

### Major results and innovations

The main achievements of the project in the reporting period are listed below:

- Finalisation of the LOCUS Architecture, as described in Figure 15 with (i) a detailed description of existing components, functions and interfaces, data flows, ML pipelines; (ii) specification of APIs and workflow. The architecture is mapped to existing standards and enables the on-demand Analytics as a Service (AaaS) system, through dedicated blocks related to operation, performing the replication/ instantiation of the requested resources and also re-parametrisation of batch computations to serve multiple simultaneous requests.

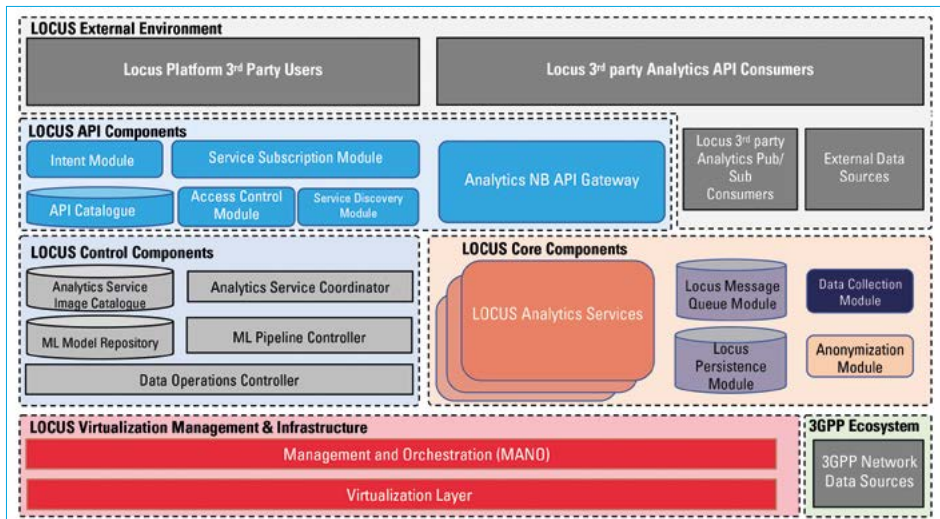

Fig. 15: LOCUS architecture



- Investigation of vulnerabilities in 5G authentication protocols and study of various privacy attack classes, design of attacks and Software-defined Radio (SDR)-based experimentation platform for capturing “IMSI-catching” attacks, study of mitigation strategies based on aggregation and obfuscation algorithms to avoid user tracking positions; exploration of adaptive (deception/masking) attack detection strategies and detection of location security attacks on non-3GPP systems.
- Derivation of final results in 3GPP compliant simulations for the 5G positioning with multiple localisation techniques. Addressed real world impediments in deriving solutions to these use cases, with machine learning and analytical solutions.
- Development of fusion techniques for 5G localisation data to be combined with Wi-Fi Access Point (AP) and Ultra-Wide Band (UWB) derived data. Development of methods to improve each single technology through geometric and machine learning algorithms, and to fuse diverse RAT-independent technologies with cellular measurements for positioning, advancing the state of the art in each field of investigation, targeting specifically: (i) Wi-Fi at sub-6 GHz, (ii) Wi-Fi at mmWave, (iii) NR and UWB, LTE, (iv) Wi-Fi and UWB, (v) NR and GNSS (global navigation satellite systems), (vi) NR, Wi-Fi and UWB.
- Derivation of fundamental performance limits for Device Free Localisation (DFL), considering the impacts of bandwidth, number of receivers and propagation conditions etc; Experiment with real outdoor channel measurements at 28 GHz using the 5G VINNI testbed at Samsung UK together with indoor UWB and mmWave MIMO radars.
- Definition of location-enabled network management functionalities grouped under four main use cases: (i) “Knowledge Building for Network Management”; (ii) “Location-aware Network Planner”; (iii) “Location aware Network Optimisation”; (iv) “Location-aware Network Diagnosis/Troubleshooting in 5G”. Deployment of the virtualisation platform in the LOCUS testbed; Consolidation of the LOCUS MANO towards the final prototype.
- Research and development of new services which implement the functionalities related to: (i) People mobility and flow monitoring; (ii) crowd mobility analytics: Group inference and crowd estimation analytics functions; (iii) Time to collision analytics research has been initiated in LOCUS project in 2021 as ‘Time to Collision as a service in V2X’ functionality for road safety applications (TRL 1-2) and concept was generalised and further extended to other verticals in 3GPP SA2 Rel-18 ‘Study of Enablers for Network Automation for 5G’ (TRL 2-3).
- A COVID-19 focus group involving many partners has been formed to develop efficient tools for flow monitoring and controlling the ongoing COVID-19 pandemic. The benefits of contact tracing via a diffused communication and localisation system such as 5G have been presented. Moreover, a method to predict hospitalisations based on stochastic differential equation and people flow models has been developed.
- Publication of several journal and conference publications in top-tier journal and international venues, including, many joint publications already published or submitted and collaborations with other projects. The partners organised a special issue of the IEEE Communication Magazine, multiple workshops at IEEE Globecom and ICC conferences, also in collaboration with other 5G PPP projects. Finally, LOCUS project will publish a peer-reviewed Wiley-IEEE book together with other experts on localisation and positioning. The book is expected to be published in 2023. A number of 76 peer-reviewed works, among joint and individual, have been already published, mainly in top-tier journals.
- An active collaboration was built with the main standardisation bodies, led by a focus group created within the consortium and driven by partners already active in some bodies such as 3GPP and ETSI. This focus group has been used to identify and propose the results of LOCUS suitable for standardisation activities. Samsung and Ericsson have already initiated two co-sourced SA2 contributions in Rel-17 thanks to their collaboration via LOCUS. CNIT and IMDEA have been using the RAN implementations of open source (OAI) to develop experimental set-ups and PoC (Proof of Concept).

### Description of demos and/or trials

LOCUS has showcased its solutions in the framework of three scenarios: Smart Network Management based on Location Information of



5G equipment; Network-assisted Self-driving Objects; People Mobility & Flow Monitoring, including emergency services. A LOCUS Platform prototype setup in the OTE testbed which includes all the main functional blocks,

and in complete alignment with the LOCUS Architecture was used to realize the two PoCs related to network management and people mobility, according to different storylines as summarised in Figure 16.

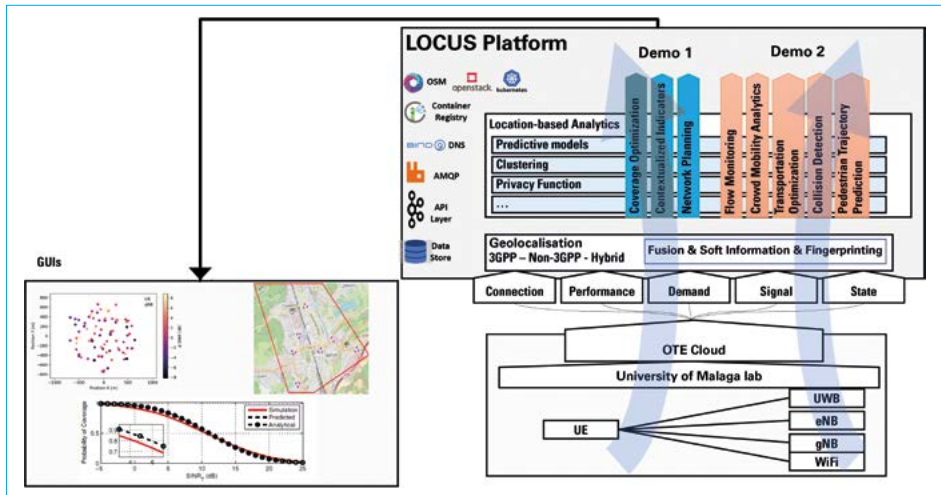

Fig. 16: Overview of the LOCUS PoCs

### Vertical use cases addressed in 5G PPP

Agriculture and agrifood, Automotive, eHealth and wellness, Energy, Industry 4.0,

Media and Entertainment, Public safety, Smart cities and utilities, Smart airports/ ports, Transport and logistics

## MonB5G

### Distributed management of Network Slices in beyond 5G

Coordinated by Engin Zeydan (CTTC)

November 2019-April 2023

Website: <https://www.monb5g.eu/>

Twitter: @monb5g

### Network management framework

MonB5G project<sup>28</sup> presents hierarchical, fault-tolerant, AI-based, automated network management framework that includes security and energy efficiency techniques for

orchestrating a large number of parallel network slices.

The MonB5G system divides the centralised management system into many management subsystems, through an optimal adaptive assignment of monitoring, analysis, and

28. <https://www.monb5g.eu/>

decision-making tasks across multiple domains to achieve the concept of **Zero touch Service management**.

AI-driven zero-touch closed-loop management is based on the three administrative elements of **monitoring system (MS)**,

**analytic engine (AE)**, and **decision engine (DE)**, with feedback interfaces used to reconfigure MS, AE, and DE to meet energy efficiency, security and scalability objectives along with **network automation and service management goals**.

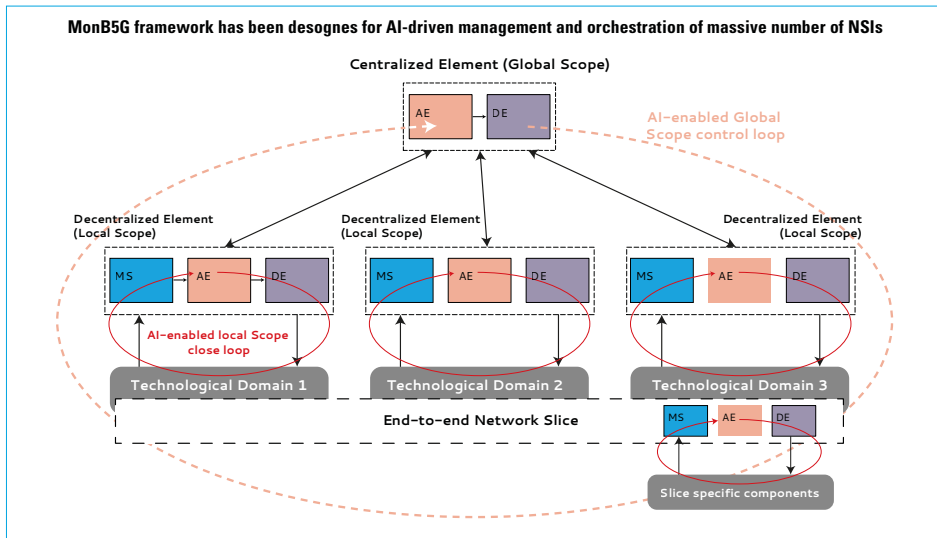

Fig. 17: MonB5G framework

MonB5G uses the concept of the **In-slice management (ISM)** that reduces the number of slices external interfaces and provides **perfect separation and higher scalability** of the slice management plane. It defines innovative **E2E KPIs (End-to-End Key Performance Indicators)** for monitoring and predicting the slice performance, trust mechanisms for **detecting and mitigating attacks** as well as **energy efficiency techniques** in a multi-stakeholder environment.

MonB5G has chosen **two use cases** to be demonstrated on the partners' 5G testbeds, including **Zero-touch service management and orchestration** across technical and administrative domains, enabling network operators to ensure end-to-end cross-domain SLAs (Service Level Agreements), and **AI (Artificial Intelligence)-assisted policy-driven security monitoring and enforcement**.

### Major results and innovations

Main key results from MonB5G include achievements in Network Management and Orchestration of Services and in Security Privacy and Resiliency as well as in Technology Enablers.

### Network Management and Orchestration of Services

- AI-driven and decentralised management and orchestration architecture, including security, of network slices, achieving the concept of Zero-touch Service Management (ZSM)
- AI-driven In-Slice Management (ISM) concept, which reduces number of external slice interfaces and separates slices' management plane.
- Multi-domain orchestration framework, which provides a strong separation between orchestration domains

## Security Privacy and Resiliency

- AI-based closed control loop framework to detect and mitigate attacks on network slices.
- Introduction of the Security orchestration and Security as a Service concept
- Trusted architecture for network slicing deployment.
- Demonstration of the capabilities of the closed control loop to detect and mitigate attacks using three use cases:
  - In-slice mMTC (massive Machine Type Communication) DDoS (Distributed Denial of Service) attacks on AMF (Access and Mobility Management Function),
  - aLTEr
  - attacks (traffic steering and VNF instantiation),
  - Attack detection and mitigation on Federated Learning (FL) training process

## Technology Enablers

- Definition of novel E2E slice KPIs for monitoring performance of slices
- Graph-based learning for slice KPI prediction
- Federated Learning for low SLA violations in beyond 5G network slicing
- AI-based Intra and Inter slice admission control
- MonB5G energy techniques:
  - Decentralised cross-domains Energy Efficient Decision Engine
  - Energy efficient at RAN and Edge
- Publication of 5G Datasets collected from project testbeds contributing to the future research of the community

## Vertical use cases addressed in 5G PPP

### Energy, Industry 4.0

# TERAWAY

## Terahertz technology for ultra-broadband and ultrawideband operation of backhaul and fronthaul links in systems with SDN management of network and radio resources

Coordinated by Hercules Avramopoulos (ICCS)

November 2019-August 2023

Website: [www.ict-teraway.eu](http://www.ict-teraway.eu)

Twitter: @TERAWAY\_EU

### Vision and objectives

TERAWAY is a 3-year Research and Innovation Action launched on November 1<sup>st</sup>, 2019. Aligned with 5G vision for a fully mobile and connected society, TERAWAY is designed to address wireless network challenging requirements imposed by 5G verticals and B5G/6G use cases i.e., ultra-high capacity, ultra-broadband connectivity, reliability, and latency requirements, exploiting **Terahertz (THz) wireless communication technology and the abundance of bandwidth offered by carrier frequencies in the 300 GHz regime.**

TERAWAY, by leveraging optical concepts and photonic integration techniques, designs and fabricates ground-breaking transceiver modules operating at the range 92 - 322 GHz, offering up to 241 Gb/s data rate with transmission reach more than 400 m. TERAWAY solution is integrated by a new software defined networking (SDN) controller responsible for the management of the network and the radio resources in a unified manner, and network services slicing.



## Major results and innovations

The most significant achievements from the initiation of the project till the end of 2022 are as follows:

**First generation of fully-integrated mmW/THz transmitter and receiver PICs** for wireless communications has been developed relying on the PolyBoard platform. The PolyBoard core of the PIC comprises tuneable lasers and optical isolators for the generation of the optical signals and the on-chip implementation of the injection locking scheme (see Figure 18).

Additionally, InP-based modulators allow for the generation of OFCs to stabilize the frequency of the lasers and for data signal modulation. In the emitter, SiN-based optical filters fabricated by the partner LioniX allow for single side-band operation.

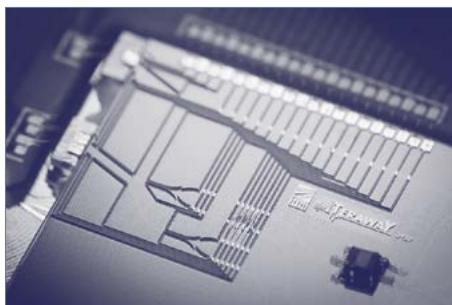

*Fig. 18: The PolyBoard comprises the tuneable lasers, optical isolators and a waveguide routing network to interconnect the different photonic functionalities.*

PICs have been packaged demonstrating for the first time fully-integrated photonic emitter and receiver modules for wireless communications.

Development of antenna structures (Si rod antennas) which allow the broad frequency coverage (90–320 GHz) and beam steering capability.

Development of the driving electronics units for the first generation TERAWAY THz TRx that control the operation of the optical components

on the PIC devices and comprise two different platforms. The first one involves a multi-channel current source that can simultaneously drive up to 120 channels and the second one involves a multi-channel high-voltage driver that can simultaneously drive up to 160 piezo-electric-transducer- (PZT) -based phase shifters.

Design of TERAWAY SDN based controller for integrating 3GPP compliant network and radio management functions: The TERAWAY system is complemented by an SDN controller that monitors and controls the links between the gNB (next generation Node B) or RRHs (Remote Radio Heads), and the fixed switch, delivering reliable end-to-end mobile backhaul or fronthaul connectivity. The software implementation of the controller is based on the open-source OpenDaylight project, that integrates Radio and Drone System controlling modules, as well as the overlay Transport Network Controller. The TERAWAY system includes a standard compliant network slicing network functions to allocate the resources based on traffic requirements. TERAWAY brings unique end to end network slice management system that integrates cmWave gNB, mmWave/THz transport and 5G Core. This consists of 6G core design that will utilize different transports to deliver network slices based on service needs.

## Description of demos and/or trials

The demo scenario consists of end-to-end network slice management system where 5G Core uses SDN controller to manage the mmWave transport. The 5GC is compliant with latest 3GPP specifications and implements network slice management architecture including RAN, Core and Transport slice management system (see Figure 19).

The demo will show how the network slice manager (NSMS) hides all the complexity of using different transport that can be based on fixed lines, mmWave or TERAWAY radios. The NSMS based on the priorities assigned to each slice will assign different VLAN to each mmWave link to provide higher capacity based on traffic requirements.

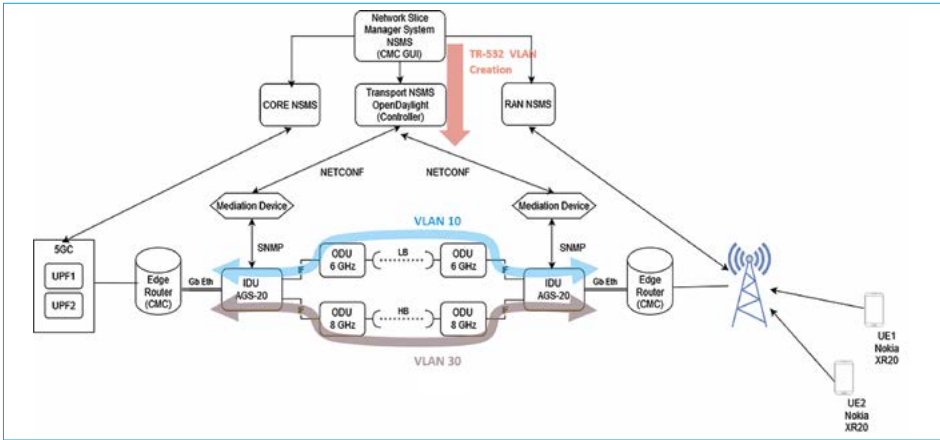

Fig. 19: TERAway Demo Architecture

## Vertical use cases addressed in 5G PPP

Media and Entertainment, Public safety

# 5GZORRO

## Zero-Touch Security and Trust for Ubiquitous Computing and Connectivity in 5G networks

Coordinated by Shuaib Siddiqui (I2CAT)

November 2019-May 2022

Website: 5gzorro.eu

Twitter: @5Gzorro

### Objectives

The **5GZORRO** envisions the future 5G networks as composed of distributed heterogeneous resources by different operators across diverse geographical areas, who in turn form an end-to-end secure chain of trust in which 5G radio, spectrum, edge and core computing, storage and networking can be shared and chained thanks to efficient and flexible mechanisms to discover, broker, trade, instantiate and monitor resources and services across the different operators' domains. However, to ensure robust,

reliable, and secure communications in future 5G, the industrial and research community needs to maintain a laser focus on the joint realisation of **zero-touch security & trust framework** and **fully automated network management**.

5GZORRO developed these envisaged solutions for zero-touch service, network, and security management in multi-stakeholder environments (ubiquitous), making use of Smart contracts based on Distributed Ledgers Technologies to implement required business agility.

## Major results and innovations

### Key research and innovations

At the core of the developed solution, there is the 5GZORRO platform, which is instantiated in each operator domain to implement the evolved 5G architecture. The 5GZORRO platform follows the principle of service-based architectures similar to the 5G Service-based architecture, and the ETSI Zero-touch Network and Service Management. Through a Blockchain based Distributed Ledgers infrastructure, the platform offers services for: 1) Smart Contracts Management, 2) Resource Discovery & Brokering; 3) Intelligent 3<sup>rd</sup>-party virtual resource selection; 4) Spectrum trading and sharing; 5) Secure SLA Monitoring; 6) Cross-domain Trust and Security mechanisms.

Within the platform, the realisation of these services is made possible through the interaction of various functions for slice orchestration, Network Intelligence and analytics, Security & Trust, Management of Service & virtualised Resources, all executed for multi-domain and single domain scope.

To address these challenges, 5GZORRO focused on the following research and innovation pillars:

- **Zero-Touch Automation:** 5GZORRO vision is achieving zero-touch automation of 5G network management, along with its many operational services and goals, its multi-party and multi-layer structure, its complexity and scale. 5GZORRO approach to zero-touch automation is driven by the idea of sharing operational data across the whole system in a logically centralised data reservoir (a.k.a. Data Lake), so that multiple asynchronous management components may act upon this shared data pool towards optimising a target set of KPIs. To facilitate open data sharing, 5GZORRO will employ permissioned ledger technology for governance of and accounting for data use.
- **Multi-party Security & Trust:** Security and trust in 5GZORRO will be designed and implemented following a principle of split between coordination actions to be taken at the inter-domain layer and actions/enforcements per domain. It will be the Cross-domain Security & Trust functionality in the Inter-domain Layer of 5GZORRO the container of end-to-end security and trust parameters, policies and ML models that will help instantiating 5G services

across multiple parties ensuring the required level of security and trust. All these efforts towards a risk-free 5G multi-stakeholder scenario will also require the definition and creation of novel ML models supporting risk analysis processes as well as the detection of software vulnerabilities and compromises and the provision of a potential set of countermeasures for any of these detected vulnerabilities and its implications on the network services.

- **Distributed Ledgers with 5G:** 5GZORRO aims to integrate the distributed ledger technologies with 5G as part of its design for the evolved 5G service layer with support at the system level as well. The evolved 5G service layer envisaged by 5GZORRO sits on top of a DLT infrastructure which has at its core a number of permissioned consortium based Blockchain networks, built on top of open source technologies such as Ethereum and HyperLedger. The Blockchain networks act as trusted data layers for SLA enforcement, resource discovery and spectrum management.

### Main achievements

The 5GZORRO consortium has successfully completed all its set objectives and technically validated the developed solution using three use cases (described later) in two testbeds, namely 5GBarcelona and 5TONIC. We present the key achievements below in brief.:

- **Marketplace and Governance anchored in DLT**
  - *Resource and Service Offer Models:* Spectrum, RAN elements, Edge/Core Cloud resources, VNF/CNF modelled based on TMForum offering specs (Product-TMF620, Service-TMF633, & Resource-TMF634)
  - *Smart Contract Lifecycle Management:* It enabled publishing, management, and retrieval of Product offerings and product orders in the DLT. In addition, it allows attachment of SLAs and e-License to Product offers.
  - *Identity and Permission Management:* It generates unique identifiers in the 5GZORRO ecosystem to identify and authorize entities, services, and organisations to access provisioned services and resources in 5GZORRO marketplace.
- **Zero-touch Service and Resource Orchestration (with Security & Trust)**

– *Intelligent Slice and Service Management (ISSM)*: It consists of ISSM workflow manager that orchestrates business workflows in the 5GZORRO platform and ISSM optimizer that is responsible for resource selection on the 5GZORRO marketplace.

– *E-License Management*: This module enables full automation in e-license management in cross domain environments while providing a global view of the usage and compliance with agreed license terms of xNFs.

– *Trust and Reputation Management Framework*: This framework plays a pivotal role in the selection of partners for business relations. It enables end-to-end trustworthiness establishment for distributed stakeholders by gathering reputation information, not only from a specific service or slice but also from its resource or service providers based on automation and zero-trust approaches.

– *Trusted Execution Environment Security Management*: 5GZORRO platform integrates zero-trust hardware platforms as a root of trust, especially for data monitoring and end-to-end secure communication. 5GZORRO solution make use of SCONE framework to allow secure and trusted instantiation of container-based services in a TEE (Trusted Execution Environment) environment.

• *Cross-domain Analytics and Intelligence*: The cross-domain analytics and intelligence for AIOps combines big Data and AI to automate IT operations, leveraging on the Operational Data Lake as data platform, feeding to zero-touch automation of multi-domain 5G operations.

– *Smart Resource and Service Discovery (SRSD)*: This module provides an intelligent resource and service discovery based on a high-level intent-based product requests in 5GZORRO marketplace. It computes a subset of offers based on multiple criteria (e.g., location, price, service and resource type, etc.) and recommends a list of suitable products based on a ranking score.

– *Intelligent SLA Breach Prediction (ISBP)*: The ISBP alerts the relevant stakeholders in the 5GZORRO platform of a potential breach of an active SLA. It actively listens for SLA events by consuming monitoring data of the network slice defined in the SLA and trains predictions models and applies the trained

model and provides notification on possible future SLA violations.

The 5GZORRO platform<sup>29</sup> consists of **16** different integrated and validated software modules with **300K** net lines of code.

The 5GZORRO project published **25 scientific papers** (13 Journals, 11 conferences and 1 book chapter) with an average **impact factor of 8.5** and a total of **214+ citations** so far. The project consortium participated in **38 events** (19 scientific and 19 industrial) while the consortium organised 6 of the events itself. In addition, the 5GZORRO project contributed to **24 adopted standards** including IRTF: RFC 9316, ETSI ISGs ZSM and PDL, ETSI ISGs NFV and MEC, ETSI ENI and SAI and 3GPP SA3.

Furthermore, the 5GZORRO project produced **44 videos (50K+ views)** to facilitate the dissemination of its proposed solution and achieved results. These videos amount to a total of **8 hours and 50 minutes** of recorded material consisting of expert interviews, tech talks, and use case demonstrations. The 5GZORRO videos are available at the project's YouTube channel<sup>30</sup>.

#### Description of demos, trials and use cases

• **Smart Contracts for Ubiquitous Computing/Connectivity**: This use case validated the creation of smart contracts for the implementation of bilateral, unilateral, and multilateral agreements within the telecoms and network ecosystem. It focuses on the tokenisation of the 5G resources and the trustless interaction between multiple parties. The UC considers multiple stakeholders that join the Marketplace, securely place their resources and services on the Marketplace, and make transactions by way of smart contracts including SLA and e-Licensing terms and conditions.

• **Dynamic Spectrum Allocation**: This use case validated the concept of dynamic spectrum management and allocation to facilitate public Wi-Fi or cellular services. It focused on the development of spectokens for flexible spectrum sharing. Spectokens were developed as non-fungible tokens which represent the right to use a non-divisible range of frequency. The UC involves spectrum providers, radio infra providers, spectrum consumers and spectrum

29. 5GZORRO platform source code is available at <https://github.com/5GZORRO>

30. <https://www.youtube.com/@5gzorro214/videos>

regulator to demonstrate how spectrum, as a digitised resource, can be dynamically shared to enhance efficiency of spectrum usage.

- **Pervasive vCDN (virtual Content Distribution Network) Services:** This use case demonstrated automated 3<sup>rd</sup> party edge resource allocation in situations of congestion or saturation of edge resources to support seamless continuity of services. It exploits several 5GZORRO features in the context of vCDN services. The use case looks at several scenarios revolving around the deployment, monitoring, and extension of CDN services through the 5GZORRO solution.

#### Vertical use cases addressed in 5G PPP

**Agriculture and agrifood, Automotive, eHealth and wellness, Energy, Industry 4.0, Media and Entertainment**





# 5G PPP PHASE 3, PART 5: 5G CORE TECHNOLOGIES INNOVATION PROJECTS

The eight Projects<sup>31</sup> retained by the EC in response to the 5G PPP ICT-42-2020 call:

5G PPP 5G Core Technologies innovation started in September, November, or December 2020.

31. <https://5g-ppp.eu/5g-ppp-phase-3-5-projects/>

## 5G-LOGINNOV

### 5G creating opportunities for LOGistics supply chain INNOVation

*Coordinated by Eusebiu Catana (ERTICO - ITS Europe)*

*September 2020-August 2023*

*Website: [5g-loginnov.eu](http://5g-loginnov.eu)*

*Twitter: [@5G\\_Loginnov](https://twitter.com/5G_Loginnov)*

#### Objectives

5G-LOGINNOV aims at supporting the new generation of 5G-CAD terminals, new type of IoT 5G connectivity devices through technical solutions, business models and priority scenarios by deploying new CAD and Logistics as a Service in real-life port-city areas. More specifically 5G-LOGINNOV develops and deploys next generation ports & logistics hubs operation system architecture integrated in 5G networks at three main ports in Europe (Athens/Greece, Hamburg/Germany and Koper/Slovenia utilising new types of 5G IoT sensors and devices; consequently the project contributes to the optimisation of ports & logistics hubs and maintenance and to the reduction of hubs operation emissions (CO<sub>2</sub>/NO<sub>x</sub>), regulating the resulting freight traffic on the future 5G logistics corridor in EU [e.g. CAM Connected and Automated Mobility truck platooning management]. 5G-LOGINNOV goals also includes the boost of market opportunities for new actors as SMEs and Start-ups and the support to the standardisation of 5G enabled next generation ports & logistics hubs operation system to ensure interoperability, platform

openness and operation harmonisation around future 5G Logistics x-border corridors in Europe and beyond.

#### Major results and innovations

The project saw the completion of the deployment of the necessary 5G infrastructure, technology, equipment and devices in three Living Labs Athens, Hamburg and Koper, contributing to their development, integration and roll-out for the logistic hubs in the respective port operations. This achievement was supported by the development of an evaluation data management tools presenting a comprehensive overview of the planned deployment in the three sites.

Specific scenarios (Storyboards) have also been identified for each Living Lab to monitor the planning and the performance during the trial period for each use case, therefore being an effective tool for the assessment of the activities and to optimally plan and perform the foreseen evaluations. Considering the significant differences in the procedures and the involved stakeholders in each site, each storyboard collects the more appropriate information such as the approach to collect baseline and operational data, the adopted technical architecture and the overall technical bracket related to 5G technologies.

In order to enhance the Living Labs with cutting-edge solutions based on 5G technologies, this milestone has been reached with the design, implementation, and completion of the Open Call in 2021 for the selection of five SMEs/start-ups

to be incorporated in the project. The ITS World Conference in Hamburg, Germany, in 2021 served as the official occasion for the announcement of the winners. The involvement of these new actors allowed to fill the identified technological gaps in the three Living Labs linked to the adoption of 5G technologies to improve logistics and transportation operations in ports.

**Description of demos and/or trials**

A front runner of Innovation, Koper Living Lab focused on the development and demonstration of 5G technologies targeting future European ports, leading to the successful implementation of 3 (three) use cases focused on port security operation; mobile network and services deployment automation and port security operations using AI-enabled video analytics and drone base video streaming.

Emphatic in its pursuit of traffic management whilst leveraging positive environmental impact by using 5G in data exchange, Hamburg Living Lab use cases highlights focused on the implementation of a cloud-based centre (which enable situation monitoring on emission); the introduction of GLOSA (Green Light Optimised Speed Advisory) application and the activation of the Dynamic Control loop for Environment sensitive Traffic management actions (DCET).

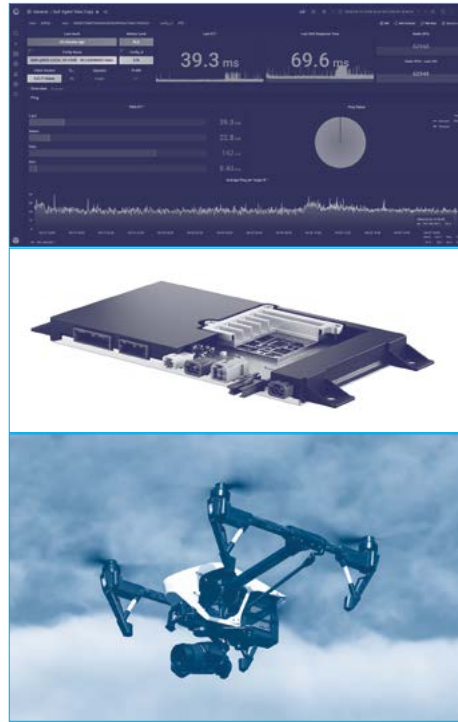

*Fig. 20: Koper Living Lab Use Cases highlights: Mobile Network and Services Automation; 5G and IoT Assisted Port Control; Drone based video streaming*

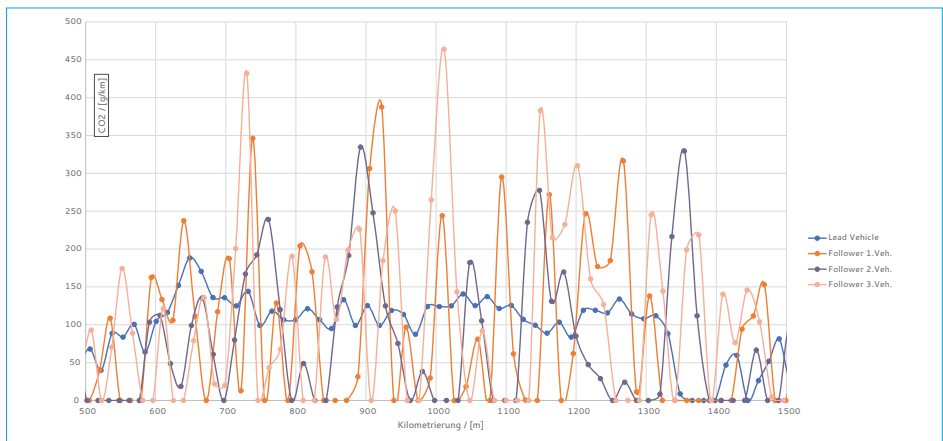

*Fig. 21: Hamburg Living Lab Use Cases highlights: Floating Truck and Emission Data; 5G GLOSA and Truck Platooning; 5G DCET.*

At the cornerstone of 5G and Innovation, the Athens Living Lab focused on 5G&AI-enabled services tailored to logistics operations as well as security and safety applications that leverage the private 5G network at Piraeus Port. Following the compute continuum paradigm various AI-service placement options have been

considered (extreme-edge and cloud) given the diverse set of requirements of the developed use cases (e.g., latency sensitive, or throughput intensive), creating a 5G ecosystem of cloud native interconnected Port assets (5G Trucks, 5G cranes, 5G IoT).



Fig. 22: Athens Living Lab Use Cases highlights: 5G Connected Yard Trucks; 5G and IoT Video Analytics via NFV-MANO Support; 5G Connected External Trucks

**Vertical use cases addressed in 5G PPP**  
**Automotive, Transport and logistics**

## Monetising car & mobility data for new Entrants, Technologies and Actors

Coordinated by Oihana Otaegui (Vicomtech)

September 2020-September 2023

Website: [5gmeta-project.eu](http://5gmeta-project.eu)

Twitter: @5GMETA

### Objectives

The main goal of 5GMETA is to provide an open, modular, flexible and trusted platform to pipeline data to innovative services for Cooperative, Connected and Automated Mobility (CCAM) applications. To this end, 5GMETA integrates innovative solutions for computing management and IoT messaging into 5G architectures on top of a scalable edge platform. Here, 5GMETA implements network functions at the 5G edge including capturing, packaging, processing, and delivery according to service-driven slicing strategies and under privacy and security constraints. Then, the 5GMETA cloud platform connects CCAM applications to configured regions of interest applying licensing policies, thus granting access to relevant data flows from target geographical areas.

The motivation of 5GMETA is to widen the mobility data marketplace beyond traditional automotive industries, comprising Original Equipment Manufacturers (OEMs), TIER1s, roadside operators and new entrants, such as tech companies, start-ups and high-tech SMEs, service, mobility and connectivity providers, insurance companies and policy makers. 5GMETA will catalyse the generation of innovative services by transforming their common needs into technical solutions. 5GMETA will flatten barriers to create innovative data-based CCAM services and applications producing new revenue flows, reducing costs and enforcing safety to application users. 5GMETA has a business-driven design with APIs and architecture ready for fast prototyping, training, and operation of new services. From there, 5GMETA will state the foundations of new data-centric business models and data licensing for data monetisation. In this regard, 5GMETA will focus on technology transfer activities to capture attention to a platform leading to new opportunities in an incoming profitable market.

5GMETA will also validate interoperability of the platform demonstrating heterogeneous innovative use cases, in terms of data heterogeneity, value creation and business models, to ensure that third parties and new players' interests and requirements are considered.

### Major results and innovations

5GMETA generates data flows with relevant data for specific services subscribed to live feeds from specific geographic areas. Thus, 5GMETA means an open API-based platform providing IoT messaging for CCAM services and applications feeding them with live data where the security, privacy, scalability, interoperability, and licensing features are provided by the 5G networks functions executed at the edge to gain low latency, capillarity and geo-based labels.

For interoperability, 5GMETA implements drivers/bindings to push live and heterogeneous data, in terms of format, sensors and vendors, from systems onboard the vehicle, such as driving dynamics, road conditions, driving behaviour and passengers' activity with personal devices, and road infrastructures, such as traffic density, average speed and issues ahead, to 5GMETA platform, recording timestamps and geo-positions. In terms of security, anonymisation, and standard ITS encryption technologies are shipped. Data ownership is a key aspect, to control, register and account the access to data according to declared licensing models. This license-driven approach can lead to diversify the market and improve the return on investment for producers by getting other revenue streams referred to data reuse. Going deeper into the economic aspects, 5GMETA enables a modular-based scalable management booking assets at the 5G network edge to process the incoming data flows according to Service Level Agreements (SLAs) fitting to a well-balanced data throughputs and processing infrastructure costs trade-off. Finally, 5GMETA platform combines edge processors to a centralised platform



combining lightweight IoT message proxies with scalable IoT message servers to provide services and applications with real-time data flows from specific areas reducing platform management and processing needs while allowing services to focus on relevant data.

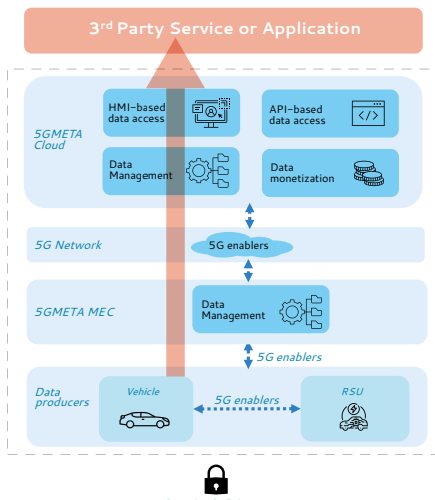

Fig. 23: 5G-META platform

### Description of demos and/or trials

5GMETA targets a direct impact in the value chain including the generation of new data-centric business models, i.e., direct monetisation from data consumers, product optimisation, i.e., reducing costs through efficient design and training iterations, or increased safety and security, i.e., casting data to multiple entities to reduce time for intervention. 5GMETA is developing three representative demonstrators in four different trial sites.

### Use case 1: R&D Live Training Loop

5GMETA pipelines live data flows including novel and singular data to improve features of new systems under development from a research and development (R&D) department. This platform bridges real-field prototypes from real driving conditions and R&D facilities, accelerating the testing and training loop of new autonomous driving and mobility systems will reduce costs of the R&D activities. This use case is being demonstrated in the San Sebastian Trial Site (Spain), which is managed by Vicomtech.

### Use case 2: Networking Parking

5GMETA pipelines the required information to accurately and dynamically predict the departure time and the optimal path to reach a destination in a target arrival time and to quickly find a free parking lot. The data delivered by the platform generate revenues from the added value to the users of an eHailing and parking service which are re-scheduled in real-time to avoid any incident meaning a late arrival. This use case is being demonstrated in the Satory Trial Site (France), which is managed by Vedecom.

### Use case 3: Driving Safety & Awareness

5GMETA provides data from Misbehaviour Detection & Response (MBDR) systems in the context of driver health or erratic driving. The aim is to protect the safety/security of road users meaning to prevent any possible collisions with surrounding vehicles and ultimately take required countermeasures to stop the misbehaving vehicle. This use case is being demonstrated in the Turin Trial Site and the Modena Automotive Smart Area (MASA), both located in Italy and managed by LINKS and ICOOR respectively.

### Vertical use cases addressed in 5G PPP

**Automotive, Transport and logistics**



## 5G key technology enableRs for Emerging media COntent pROduction Services

Coordinated by David Gómez-Barquero (UPV)

September 2020-October 2022

Website: [5g-records.eu](http://5g-records.eu)

Twitter: [@5G\\_Records](https://twitter.com/5G_Records)

### Objectives and overview

The fifth generation (5G) of mobile communications has revolutionised the telecommunications industry, allowing to explore the opportunities that this new technology brings to different verticals. 5G-RECORDS is a European H2020 project that aims to explore the opportunities that new 5G technology brings to the professional audio-visual (AV) content production sector. The 5G specifications allow for the deployment of specialist networks based on the same technologies as those operated by Mobile Network Operators (MNO). This offers the opportunity for content producers to build and operate their own networks to support their business requirements.

5G-RECORDS has considered three use cases to deploy three challenging scenarios in professional content production: live audio production, multiple camera wireless studio and live immersive media production. To ensure the successful demonstration of the use cases, the project gathered a set of experienced partners whose expertise covers both 5G and content production value chains. Together, they have designed the main components and the architecture for each use case, identifying the benefits for users, requirements, and technical enablers. Scenarios and workflows have been defined, measuring specific Key Performance Indicators (KPIs) required to validate the performance of the proposed solutions.

### Major results and innovations

The project was highly focused on both 5G and media components design, development, testing and validation on E2E infrastructures and has demonstrated significant outcomes. To sum up, the key achievements of the project are summarised below by each use case.

### Use Case 1: Live Audio Production

- Implementation, integration, and optimisation of disaggregated 5G components including wireless microphone / In-Ear Monitoring (IEM) systems application and 5GS on network-layer.
- Optimisation of 5G testbed for latency by using real-time kernels, suitable interfacing, timeouts and synchronisation of processing clocks.
- Capturing the state-of-the-art of current 5G ecosystem and benchmarking towards live audio production use case requirements
- Identification of remaining gaps in 5G ecosystem for live audio production applications
- Network integration of live audio production into different 5G testbeds
- Proof-of-concept cloud-based remote live audio production with wireless microphones/ IEMs
- Fully remote-controlled trials and measurements
- Proof-of-concept for shared access to spectrum for a private 5G network
- Proof-of-concept to transport audio and video over the same private 5G network in TV production scenarios

### Use Case 2: Multiple Camera Wireless Studio

- Test of end-to-end multi-camera live production and remote contribution.
- Analysis and testing of PTP (Precision Time Protocol) performances on 5G networks Release 15 and URLLC test bed Release 16.
- Design and integration of a portable camera interface unit inclusive of a 5G standalone modem and encoder.
- Development of the media gateway and the media operational control gateway to enable

a seamless integration of devices in hybrid network made up of 5G network and IP media production facilities.

- Development of an experimental remote camera control software. A demo of this software was shown during IBC (International Broadcast Congress (2022)).
- Test of the MCR (Master Control Room) instance.
- Validation of the network slicing in the contribution scenario and testing of a portable 5G standalone setup.
- Extensive testing of the 5G network performance in various conditions and configurations.
- Simulation of a small remote production inside RAI labs in Turin.

### **Use case 3: Live immersive media production**

- Development of a FVV system which can work on live and offline contents and is adapted for 5G and cloud production.
- Design and validation of a 5G+MEC (5G+LMulti Access Edge Computing) compact deployment.
- Deployment and testing of end-to-end transport slicing over a software-defined network, including automatic slice change.
- Integration of all the elements into two different test beds in Segovia and Madrid, and interconnection of both test beds using a commercial network with QoS (Quality of Service) guarantee.
- End-to-end live trial of a music live event, showing all the elements of the use case working together.
- Pioneer tests on immersive content production over millimeter-wave 5G RAN (Radio Access Network).
- Analysis of the performance of the system and its limitations, as well an analysis of how the

system will perform over the next generation of infrastructure elements.

5G-RECORDS partners worked to exploit the potential of 5G to greatly facilitate and possibly even revolutionize media content production. During this time, 5G-RECORDS proved that 5G components and NPNs (Non Public Networks) can be used successfully within several content production scenarios. Key novelty end-to-end architectures based on millimeter wave technology, edge computing and audio transmission over a private 5G network were developed and validated. Also, components developed from scratch such as the 5G Release-15 modem or the media gateway prototype were integrated into the infrastructures successfully. Other key components developed were the real-time end-to-end Free Viewpoint Video system, the camera interface units (CUs) or the compact 5G Core among others.

### **Description of demos and/or trials**

Several final trials were successfully deployed to validate the 5G-RECORDS components and E2E solutions in the context of the three project use cases.

### **Live Audio Production**

The use case disaggregated testbed was located in Sophia Antipolis, France, using Eurecom's infrastructure. It integrated the 5G-enabled microphones and IEM systems, the COTS RUs, and the open-source OAI (Open Air Interface) gNB-DU (Distributed Unit), the CU the compact 5GC (5G Core) and spectrum sharing management technologies. During the trials, the use case partners identified that some components introduced significant latency jitter into the processing and forwarding of audio IP packets in the 5GS. Even if the use case network has evolved gradually during the project to reduce latency, the one-way network latency achieved was finally about 10 ms for a single audio UE and about 20 ms for up to three audio UEs. (User Equipment). The availability and maturity of available 5G components remained a major constraint until the end of the project.



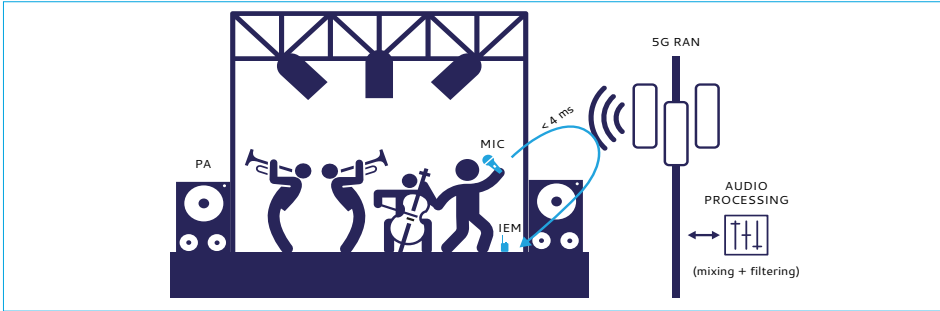

Fig. 24: Live audio production scenario.

In addition, the consortium partners were able to conduct mobility tests to better understand the use-case KPIs in a more realistic environment. The UE was connected to the 5G network and moved around in the lab premises. Also, this the team was able to collaborate with use case 2 partners during the trial in Tivoli Garden to demonstrate the delivery of audio and video over the same 5G network, and to conduct latency measurements as part of the evaluation of the state-of-the-art 5G components.

### Multiple Camera Wireless Studio

Several tests were performed by the use case towards the technology validation and execution of the final trial at Tivoli Garden, Copenhagen. Despite several setbacks, it was possible to perform the desired tests and trials, which focused on PTP performance, remote production, local production, gateways, camera controls, glass-to-glass latency measurement, among other topics in Aachen, Turin, Copenhagen,

and Valencia. The PTP tests were successful in demonstrating that PTP over 5G is sufficient for frame-level synchronisation. It was also demonstrated that the basic PTP performance can be greatly enhanced by client tweaking and using advanced TSN features (from about 117  $\mu$ s to 3.6  $\mu$ s median offset).

In Aachen, Germany, the team was able to integrate the media gateway into the infrastructure. The tests allowed the team to study the traffic behaviour, frame delay, interarrival, packet latency among others. In summary, the most important KPIs such as E2E latency and uplink throughput have been measured and validated, with a glass-to-glass latency of around 200 ms and 50 Mbps per video stream. Later, the final trial in Tivoli was performed, in which the E2E system was tested. The trial was a success, as professional content production could be carried out thanks to the developed components (such as the encoder-5G smart board, media gateway, MOCG, etc.) via 5G connection.

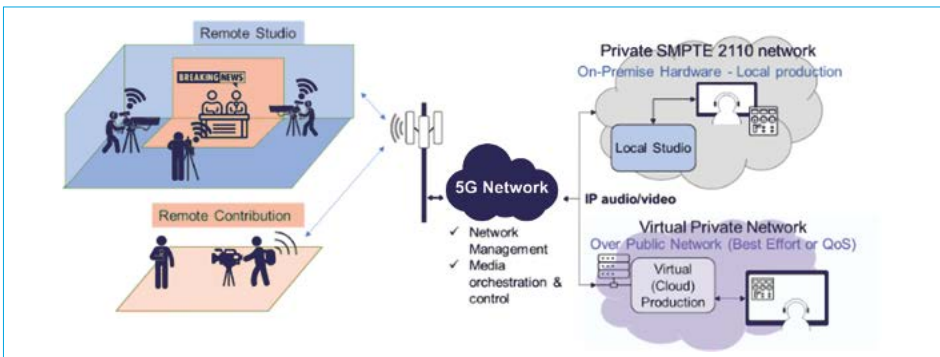

Fig. 25: Figure 25: Multiple camera wireless studio



### Live immersive media production

During the use case final field trial, the viability of a full E2E FVV live deployment to stream and record an event over a 5G network was demonstrated. The trial was chiefly intended to bring the use case into a real environment and validate

each of the modules and components. This final trial was successful and provided relevant information as a result of all the work carried out during the project. The event consisted in a live music performance by professional artists which was produced as a FVV service in real-time and streamed to the final user.

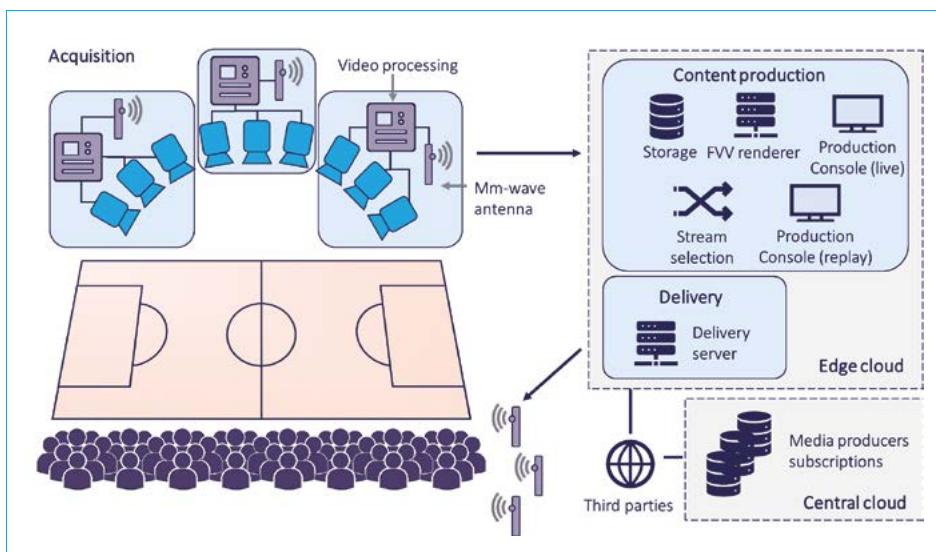

Fig. 26: Live immersive media production scenario

The event took place in Nokia premises in Madrid (Spain), and the FVV content was also recorded to demonstrate the FVV playback functionality of the system. Furthermore, Grafana dashboards were shown and monitored during the whole session. The results collected provide useful insights on options to reduce, if necessary, the amount of data to deliver FVV providing the highest possible quality to the end users. Also,

they can help define trajectories that can be appealing for the users. Regarding the delivery network, we can certify that the expected KPIs have been met for four different scenarios and the whole setup is working as expected with two QoS slices.

### Vertical use cases addressed in 5G PPP

#### Media and Entertainment

## DRAGON: D-band Radio 5G network technology

Coordinated by Vladimir Ermolov (VTT)

December 2020-December 2023

Website: [h2020-dragon.eu](http://h2020-dragon.eu)

### Objectives

In the next three to four years, communications service providers (CSPs) will run backhaul transformation projects to meet the needs of 5G and beyond Radio Access Network (RAN) service provisioning. With mobile data traffic continuing to grow rapidly and the imminent connection of 50 billion Internet of Things (IoT) devices by 2025, CSPs are being driven to rethink their existing transport network architecture. The DRAGON project, through the exploitation of the D-band (130–174.8 GHz) spectrum, will overcome the constraints of current E-band wireless backhaul solutions to achieve a small-form factor and high-capacity radio solution, suitable for massive deployment, that will enable bringing the speed of optical systems to backhaul systems in a cost-effective way. Opening to the introduction of frequencies beyond 100GHz towards 100Gbps capacity, DRAGON supports the deployment of different applications and use cases for high-capacity x-haul systems having hop distances of up to 1 km. DRAGON offers prospects for new semiconductor, antenna and packaging technologies and the consequent hardware devices to enter the market and to create economic opportunities. A beam steering integrated antenna array using an intelligent low-cost packaging technology will be developed for the implementation of the 5G network demo trial on field, with fine beam alignment for facilitating the installation and compensating pole vibration.

### Major results and innovations

DRAGON is developing low-cost and small form factor components, systems, and algorithms, to enable flexible, high throughput ( $\geq 100$  Gbps) and power efficient D-band wireless backhauling/front hauling into current and beyond 5G mobile networks. The project leverages and advances a mix of cutting-edge technologies:

- Prototyping and engineering a highly integrated D-band transceiver analogue front-end chip set in low-cost Silicon-Germanium (SiGe BiCMOS) process and a reliable mmW substrate technology for active antenna array packaging and industrial-ready assembling.
- Development of a Segmented Active Phased Array Antenna Systems (SAPAAS) with  $\geq 1024$  elements and  $\pm 5$ -degree beam steering accuracy.
- Integrating an inexpensive and mass producible SiGe BiCMOS with multilayer Antenna-in-Package (AiP) and proper thermal management for SAPAAS power dissipation technologies to make low-cost, low-power large segmented phased arrays possible.
- Implementation of a fully digital management of the transceiver including beam-steering / beam-forming functionalities, factory calibration, energy saving, Automatic Transmit Power Control (ATPC), Remote Transmit Power Control (RTPC), controlling, pointing, focusing and beam nulling.
- Prototyping a base-band processor with integrated dual carrier solution, with embedded Cross Polarisation Interference Cancelling (XPIC) technology, ready for Line of Sight Multiple Inputs Multiple Outputs (LoS-MIMO) and/or Full Duplexing canceller (FD-canceller). Support of 25Gbps network Interface (towards  $\geq 100$ Gbps throughput), with an optimised network traffic signal processing including the carrier aggregation.



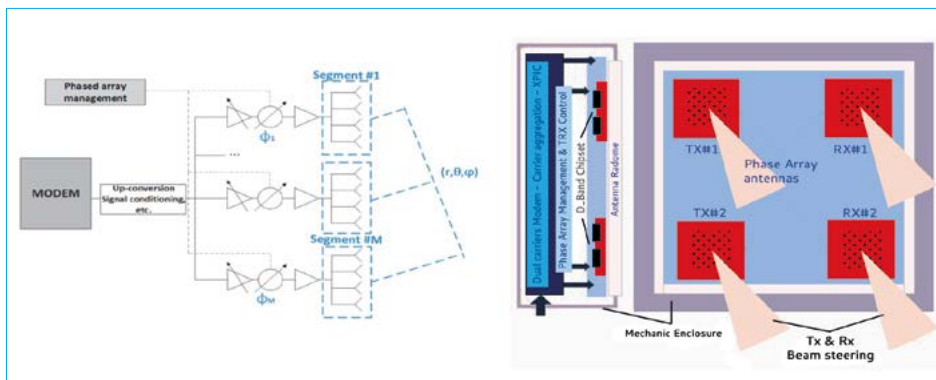

Fig. 27: DRAGON phased array architecture and demonstrator

### Description of demos/trials

The DRAGON target demonstrator will prove the feasibility of a wireless front/backhaul link exploiting the mmWave 5G core technology with field trials on a fully operating 5G network. The low power, and low form factor full radio transceiver solution comprises the mmWave section integrated with the antenna array in a low-cost packaging technology, interfaced to the modem, baseband, and control platform, mounted on an advanced multi-tile hardware platform including electromechanical design and thermal management. The demonstrator provides the following features:

- D-Band frequency spectrum with > 100 Gbps capacity
- Large active antenna array ( $\geq 1024$  elements)
- $\geq 256$ -QAM digital base band processor with adaptive modulation
- Dual carrier MODEM for flexible Frequency Division Duplex (fFDD), with embedded XPIC or 2x2 LoS MIMO ready for 4x4 LoS MIMO
- Hop lengths of more than 1 km with high availability

- Base band algorithms for the traffic management and adaptation, network interfaces and the carrier aggregation
- Reconfigurable antenna beam direction, by fine steering feature of the segmented antenna concept
- Small form factor and low visual impact (suitable for street level), allowed by the full and compact integration of the antenna array and the BiCMOS based transceiver ICs
- Installation and commissioning facilitated by beam steering capability
- Low power consumption and low cost

The prototype demonstration in an operational environment and even above, with on-field trials on a real 5G network by a telecom operator will allow running evaluation, impact assessments and identification of business cases and cost/benefit analyses.

### Vertical use cases addressed in 5G PPP

#### Smart cities and utilities

## Fully Disintegrated private nEtworks for 5G verticals

Coordinated by David Gomez Barquero (UPV)

September 2020-March 2023

Website: [fudge-5g.eu](http://fudge-5g.eu)

Twitter: @fudge5geu

### Objectives

The main objective of FUDGE-5G is to devise, assess and demonstrate a conceptually novel and forward-looking cloud native, unified and secured service-based 5G architecture, solutions and systems for Non-Public Networks. FUDGE-5G will allow for extreme interoperability and customisation for verticals among wired and wireless access infrastructure, eSBA (enhanced Service-Based Architecture platform), and systems for Non-Public Networks.

FUDGE-5G will allow for extreme interoperability and customisation for verticals among wired and wireless access infrastructure, eSBA platform, multi-vendor mobile 5GC, service orchestration and vertical applications.

Five vertical use cases will be used for validating the FUDGE-5G technology solutions. Each use case is associated with a vertical stakeholder, which will be involved both in the use case definition and in the field trials.

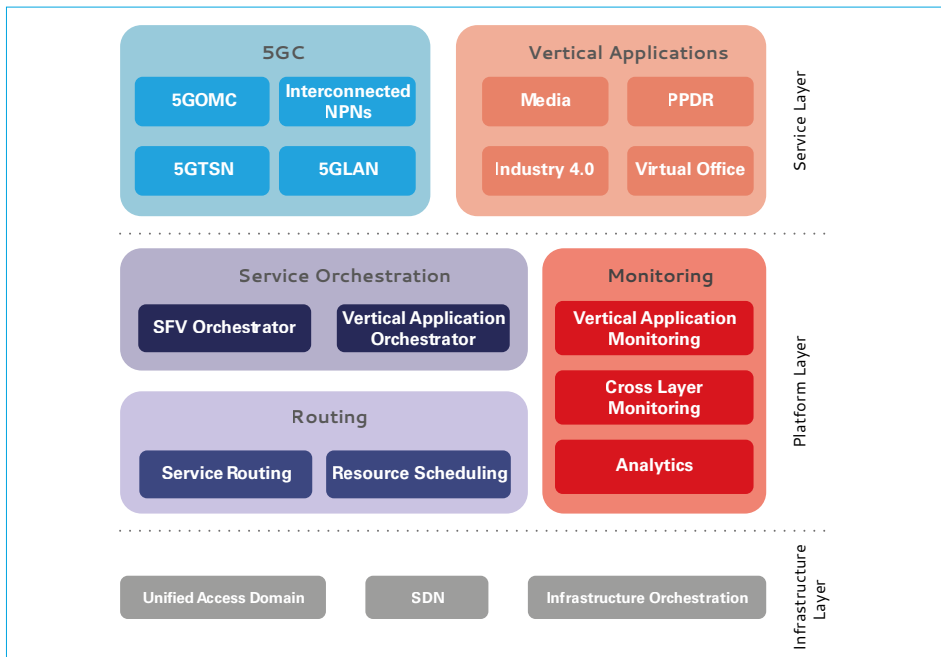

Fig. 28: FUDGE 5G architecture

### Description of demos, trials and use cases

#### Use Case 1 – Remote Media Production

The Remote Media Production trial relies on collecting loss-less or almost loss-less video

content from several cameras and delivering it reliably to a remote professional content production studio.



The main goal is to ensure a stable end-to-end wireless connection in an outdoor environment between the cameras, the 5G SA on the Network on Wheels (NoW), and the backhaul link to the public cloud.

The equipment used inside the Network-on-Wheels is composed of: ATH exBox, Huawei RAN, AviWest PRO4, VideoXLink, and several professional cameras. These cameras are attached to a 5G-NPN (Non-Public Network), capture the source content, and radiate it using 5G New Radio while being spread around the area of the trial.

Then, the synchronised video flows are sent by the 5G Modems and arrive to the 5G SA core on the Network on-Wheels, that features a backhaul connection (depending on the trial site, 100 to 200 Mbps connections have been used) to NRK Central Offices and a Private Cloud.

The trial was conducted in 4 different areas of Norway, both for outdoor experiments of the setups and the actual coverage of the events themselves, including a ski event, a marathon, and other sports events; even airing live in a national broadcast the content captured over 5G. The outcomes of the trial reflect a strong performance of the 5G retransmission coverage, with 70 Mbps upstream and 280 ms latency, including encoding and UDP (User Datagram Protocol) retransmission. The maximum distance covered was about 3 km due to urban scenery, but it is possible to reach a larger distance when elevating CPEs and using multiple gNBs. It would be possible to improve to optimize these KPIs by fine-tuning the radio parameters and using customised frame structures that favour the uplink part of the use case.

### **Use Case 2 – PPDR (Public Protection and Disaster Relief)**

The main trial objective was to showcase the potential and the ability of a standalone private 5G network to allow broad band capabilities to first respondents and special forces.

The trial validated the integration of 5G Stand Alone (SA) components along with the use of PPDR specific vertical applications (OneSource Mobitrust situational awareness platform and video distribution app) within the Network on Wheels (NoW). Thus, the trial demonstrated the quick and urgently setting up of secured autonomous 5G bubble with all the services

capabilities within the area along with showcasing the capability of multiple video streams from HD cameras, carried by dismounted operators or the drones, towards a video server hosted at the NoW. The trial also logged the downlink and uplink throughput of 433 Mbps and 130 Mbps respectively for the 40 MHz bandwidth along with multiple live HD streams to different locations.

Similarly, in a second trial along with repeating the aspects of first trial we also showcased the Nemergent MCX PTT application in collaboration with Affordable 5G. The team was equipped with mobile phones with Nemergent PTT client installed. The PTT system was configured with three user groups, each with different members and affiliations. Group A consisted of the Search and Rescue mission team, including representatives from the Politi, NLA, and NDMA. The first respondents were able to communicate effectively with each other through video, text, and voice.

The trials were great success and highlighted the effectiveness of the nomadic 5G standalone network and Nemergent PTT application in supporting critical communications during emergency operations, especially when traditional communication systems are unavailable.

### **Use Case 3 – 5G Virtual Office**

The trial took place at Oslo University Hospital (Rikshospitalet), Norway and two different scenarios were tested. The first scenario used the NPN deployment to enable remote monitoring of ward patients using a set of bio sensors, allowing smart processing and analysis to trigger alarms in case abnormal values were detected, as well as doctor to patient remote and live interaction. The second scenario aimed to validate reliable and quality monitoring when patients are transported within the hospital premises, in contrast to what is currently achieved in such scenarios. During the trial, a number of KPIs were collected in order to validate both the network and the Virtual Office vertical application (Mobitrust). These can be divided into validation of: message transmission, video streaming and 5G components.

- To determine the message transmission delay, two different sets of values were collected. The first set consisted in the Round Trip Time (RTT) of messages with minimum payload, registering 34 ms on average, with values as low as 5.7 ms. The second set included the time to collect data from the bio sensors and adding them to the



payload, registering 49 ms on average with a minimum of 7.1 ms.

- For video streaming validation, the most relevant indicator was the video delay when viewing HD streams. This includes video capture time, encoding, transmission over 5G, and distribution to watchers from a microservice in the Mobitrust platform. It averaged 350 ms, with the lowest values below 300 ms and highest values slightly above 400 ms.
- The validation of the 5G components was performed by monitoring the radio signal quality, with an average Reference Signal Received Power (RSRP) of -60 dBm and Reference Signal Received Quality (RSRQ) of -10 dB. Moreover, data rates were also collected with the following median values: 888.1 Mbps of Download (DL) and 65.4 Mbps of Upload (UL).

#### Use Case 4 – Industry 4.0

Another important research topic in FUDGE-5G is the deployment of a 5G private network in an industrial scenario. This includes the 5G integration, validation, and demonstration through different application use cases, happening in the industrial lab from ABB, located in Fornebu, Norway. The integrated components are a 5G core from Cumucore, 5G radio infrastructure from Nokia and 5G devices from Fivecomm. Different test applications are also being onboarded in the end-to-end architecture.

So far, the validation of the 5G components has been made by means of network KPIs. The evaluation included 5G RTT latency values (between two 5G devices) of 40.3 ms on average; one-way 5G latency (device to 5G core) of 17.7 ms; throughput values up to 950 and 44 Mbit/s in the DL and UL using UDP; and radio signal quality, with an average RSRP of -72 dBm, RSRQ of -11 dB and Signal to Interference & Noise Ratio (SINR) of 27 dB.

During the coming weeks, the different test-cases including the application will be executed. The trials will consist of four test-cases, i.e., remote monitoring as a service, remote control as a service, 5G adaptability in industrial environments, and process control.

#### Use Case 5 – Interconnected NPNs

In the Interconnected NPNs use case, small-sized 5G private networks are deployed and interconnected to provide a coherent, secure, and reliable communication environment. The

main innovation of this use case is to have a distributed authentication framework in 5G for roaming devices. Two scenarios for roaming are showcased for visited subscribers: local breakout where authentication is performed in the home network and data traffic is offloaded from the visited network to the data network; home-routed roaming where, along with authentication, data traffic is offloaded via the home network. Fraunhofer FOKUS Open5GCore testbed was used for this use case.

To accomplish the use case, one new component Session Border Controller (SBC) was developed, as a 5G control plane function, by Fraunhofer FOKUS to route secured messages between the private networks deployed in Berlin, Valencia and Oslo. In order to validate the functionalities first phase of the trial was performed between Berlin and Valencia. At Valencia, ZTE modems were connected with the Amarisoft cell to perform the test. A local breakout scenario was executed and corresponding KPIs were collected from the 5G core network. As the authentication of the visited subscribers is handled by the home network, the duration of the registration procedure was measured for the visited subscribers and compared against the duration for the local subscriber to the visited network. Based on the results it can be concluded that SBC added around 3–8 ms overhead in the procedure and the duration is dependent on the best-effort network between the two locations.

For the second phase of the trial, the home-routed roaming scenario was tested between Valencia and Berlin. The session establishment duration for the visited subscriber which is handled by both the visited network and home network was compared with the local breakout scenario where the session is created only by the visited network. For the home-routed scenario, the PDU session creation procedure took around 3–4 ms more than the local breakout scenario. For the data path, iperf tests were performed, the throughput was less than the local breakout scenario as for home-routed roaming the data path capacity depends on the backhaul. In the second phase also the third location Oslo was connected and roaming functionalities were tested between the three locations.

#### Vertical use cases addressed in 5G PPP

**eHealth and wellness, Industry 4.0, Media and Entertainment, Smart cities and utilities**



## Integrating 5G enabling technologies in a holistic service to physical layer 5G system platform

Coordinated by Hercules Avramopoulos (ICCS/NTUA)

November 2020-October 2023

Website: [www.int5gent.eu](http://www.int5gent.eu)

Twitter: @int5gent

### Challenge and objectives

#### The Challenge

The necessity of an enabling 5G infrastructure, from the data plane technology blocks to the control plane and application deployment layer, is of paramount importance to maintain the market penetration momentum of 5G, generating in turn the functional requirements for meeting the expected 5G key performance indicators and therefore supporting the creation and growth of truly innovative vertical markets. From the networking point of view, the increasing interest in new use cases with strict latency requirements, fast service deployment times, dynamicity and trustworthiness generates a clear trend towards distributed network models implemented through the edge computing concept. According to this concept, the execution resources (compute and storage) are positioned at proximity to the end users and data generation sources. This denotes the deployment of an advanced infrastructure at the access and metro segments able to provide sufficient data transport connectivity and management of physical and virtualised network functions for a large number of distributed nodes. The complexity increases further by considering different types of edge nodes that may span from simple gateway servers to mini-data centres (DCs), thus having different connectivity requirements.

From the data plane point of view, the new technology building blocks should enable the 5G network infrastructure to provide the flexible high capacity and expandable connectivity between 5G terminals and edge computing nodes as well as among mobile edge, computing and content delivery nodes, and the core infrastructure also supporting the legacy cloud computing level. For this purpose, the move towards higher operating bands (V, W and even D-band) and the deployment of photonic interconnection solutions are

necessary and require efficient elements for data distribution and demanding RF electronic system designs. In addition, the service level requirement for low latency in combination with new intelligent processing algorithms at the edge node denotes the deployment of edge processing units able to handle such services in real time and flexibly in terms of resource usage.

Within this highly demanding environment, Int5Gent aims to deploy a holistic 5G system platform that combines new technological blocks for the data plane infrastructure orchestrated by flexible PNF-VNF instances over a generalised NFV Infrastructure (NFVI) that is extended to edge computational, storage and networking resources. The overall goal is to integrate innovative solutions at different development layer of the 5G stack and combine them optimally in the quest to promote true 5G enabling solutions for new technology and service provisioning vertical markets.

#### Objectives

Empowered by its ambitious vision, Int5Gent aims to seamlessly interconnect access nodes supporting any type of IoT device and related services over a bandwidth flexible and adaptive fronthaul/backhaul infrastructure and control and manage the network and computational resources, as well as orchestrate the lifecycle of the deployed service functions. More specifically, Int5Gent will:

- Develop a mmWave point-to-multipoint (PtMP) mesh node to enhance the connectivity of IoT devices in support of low-latency computing at the edge.
- Develop D-band 5G Terminal Nodes supporting flexible co-packaged electro-optics interfaces for practically unlimited fronthaul/backhaul transport capacities.



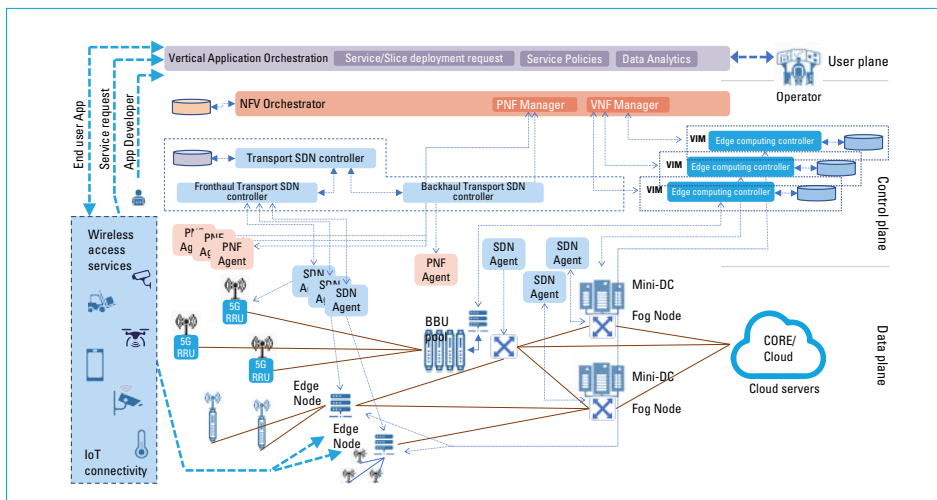

Fig. 29. Int5Gent architecture

- Develop a multi-stream bit-interleaved sigma-delta modulated interface for bandwidth-efficient, low-power interconnection between edge box and frequency agnostic 5G RRU (Remote Radio Head) nodes.
- Edge-Box deployment based on advanced baseband processor platforms for MEC-oriented use cases.
- Architect a truly flexible 5G C-RAN with re-configurable optical fronthaul interfaces and “on-demand” optical bandwidth-capacity steering functionalities
- Dynamic application driven orchestration of network slices in distributed 5G infrastructures with edge-fog computing capabilities.
- Develop an end-to-end 5G network slicing management and orchestration framework to dynamically reconfigure a multi-technology network at service runtime.
- Validate 5G technological blocks in a series of scalable lab- and field-trial demonstrators targeting service-oriented use cases.
- Deliver a holistic roadmap for transforming Int5Gent innovations into business opportunities with strong 5G market potential.

### Description of demos and/or trials

The project’s integration activities will lead to the setup of large-scale demonstrators, histed in two extended testbeds which include actual

field deployed segments and managed by the network operators of the consortium. The validation and showcasing testbeds host different use case scenarios covering the deployment of services related to multiple vertical sectors as well as innovative applications for smart IoT networked devices.

Int5Gent has already carried out its first demonstrator, showcasing its envisioned multi-technology RAN topology. The conducted demonstrator took place at ICCS campus, located in Athens, Greece, on January 26, 2023. It focused on showcasing the simultaneous operation of three inhomogeneous access links, co-hosted in a common access infrastructure. The three access technologies that were employed were standard D-RoF (digitised radio-over-fibre), extended via a PtP E-band wireless bridge, an SDoF (Single Degree of Freedom) scheme and an A-RoF link that utilised the project’s prototype D-band radio transceivers, enabling analogue fibre-Wireless connectivity. All three transport paths were dynamically routed to their corresponding radio terminals through an Arrayed Waveguide Grating Router (AWGR)-based optical node via wavelength tuning and delivered real-time services, such as mobile traffic and UHD video streaming.

### Vertical use cases addressed in 5G PPP

**Smart cities and utilities, Transport and logistics**



# 5G PPP PHASE 3, PART 5: 5G FOR CONNECTED AND AUTOMATED MOBILITY

Four Projects<sup>32</sup> were selected in response to the 5G PPP ICT-53-2020 call: 5G PPP 5G

for Connected and Automated Mobility (CAM) started late in 2020. Some will be active since mid-2024.

32. <https://5g-ppp.eu/5g-ppp-phase-3-5-projects/>

## 5GBLUEPRINT

### Next generation connectivity for enhanced, safe & efficient transport & logistics

*Coordinated by Wim Vandenberghe (MIW Netherlands)*

*September 2020-August 2023*

*Website: [5gblueprint.eu](http://5gblueprint.eu)*

*Twitter: [@5G\\_Blueprint](https://twitter.com/5G_Blueprint)*

#### Objectives

In 1995, the “No Hands Across America” experiment by Carnegie Mellon University’s Robotics Institute managed to tackle 98.2% of an over 2800-miles trip via autonomous driving: since then, the entire industry has been working hard to identify, test and optimise upon that remaining 2% of traffic situations, where unusual operating circumstances may take place, to guarantee safety. That’s where 5G-Blueprint comes in, focusing on an alternative approach to these challenges: direct control teleoperation and automation complementing each other. Direct control teleoperation can allow splitting up L4 vehicle trajectories in different segments with different Operational Design Domains and assign each of them to either automated driving or remote driving – where humans perform the actual dynamic driving task – depending on how difficult they are to automate. This would also reduce personnel costs, as human drivers will

not need to be physically present in the vehicle anymore and could remotely jump in and out to take over whenever needed. 5G finally made this concept feasible, but the seemingly needed combination of eMBB and URLLC – alongside seamlessly cross-border connectivity for international transport – might be still too challenging to realise. It is 5G-Blueprint’s mission then to validate in depth if and how 5G can provide the connectivity needed for direct control teleoperation, from the technology, business, and governance standpoints.

To validate the performance of use cases and enabling functions over the 5G network, we created three pilot sites. These pilots are benchmarked on the basis of the current network solutions (e.g. LTE) in order to validate 5G advantages on a full-scale level on both private and (cross-border) public roads within the designated pilot areas.



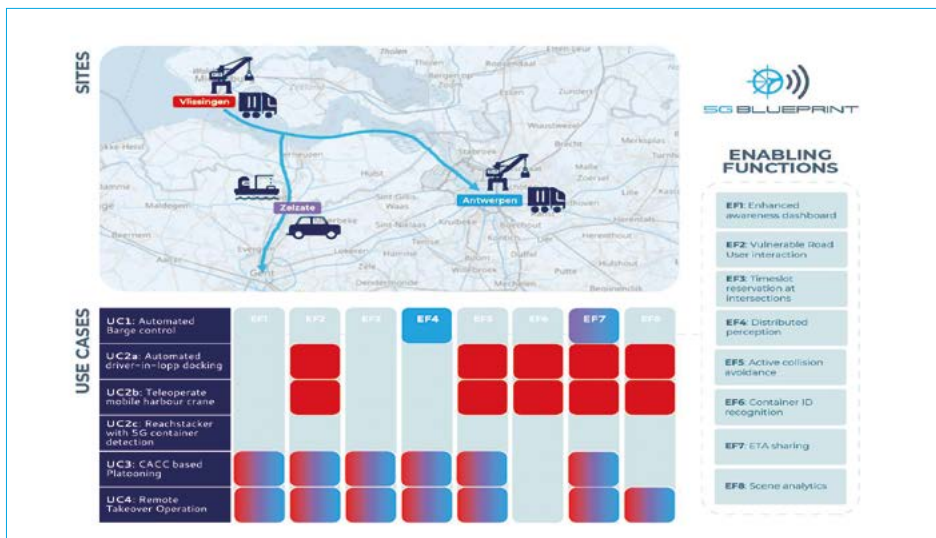

Fig. 30: 5GBLUEPRINT use cases

### Major results and innovations

One of the main achievements is the **techno-economic analysis of teleoperated transport using 5G technology**, aimed at evaluating its feasibility, particularly in a cross-border setting. The results showed that it is not possible to identify a single network deployment approach that is the most cost-effective approach for all possible deployment scenarios. Other main recommendations from the study can be summarised as follows:

- **Reduce the use case requirements for the uplink capacity** to save (connectivity) costs taking into consideration also the potential additional cost for such development/implementation.
- **Smart deployment of small cells in addition to macro cells** for enhancing uplink capacity in a network deployment, but not without limitations.
- **Adopting cost saving strategies for network deployment** such as passive and active network sharing to significantly reduce the network overall deployment cost.

**From the perspective of use cases and piloting activities**, the first stage of the project has been entirely focused on the design, testing and validation of the Minimum Viable Platform

for all use cases and enabling functions. In terms of 5G network deployment for testing, the project focused first on the 5G NSA network, due to the availability of radio spectrum. Although more testing on 5G SA, leveraging on eMBB and URLLC network slices are currently ongoing, the MVP phase of piloting activities showed already enhancements of the network performance and on teleoperation-specific KPIs (such as accuracy in steering angles, throttle positions, brake positions, and the distance between lead and ego vehicles in CACC-based platooning scenarios).

For a brief breakdown of setups and main takeaways:

- **A driver-in-the-loop docking test** in the Vlissingen pilot site, featuring a scaled truck trailer combination and 5G equipment. The results show the maximum value of tracking error is 1.3cm, with the average of 0.4cm: a promising result, as it meets the requirements of less than 2.5cm.
- **Tests including 5G-enhanced CACC-based platooning** integrated with the enabling functions, performed in shadow-mode (sending teleoperation commands to the teleoperated vehicle, without application to the UE side). The enabling functions provided an extended and enhanced awareness to the teleoperator to increase safety of teleoperation,

with less than 5% error between lead and follow vehicle (target value domain), and maximum achievable speed of 90km/h.

- **Remote takeover tests**, where remote driving enhanced by enabling functions was tested over 5G connectivity. The results that were achieved in the Vlissingen pilot site show, throttle (obtained error 3%, required less than 6%), and brake accuracy (obtained error 5%, required less than 6%).
- A promising **cellular-based automated barge control system** created in the real-life environment of the Port of Antwerp Bruges, featuring a sailing barge, connecting dynamically to the available 5G NSA network. Based on the results registered, 5G outperforms 4G both in terms of latency (~15ms vs. 27ms), and bandwidth on the uplink (24Mbps vs. 36Mbps).

In general, all these results from the MVP (Minimum Viable Product) phase are showing good consistency between the KPI target values and data measured in the pilot sites using the 5G network. The main focus of our ongoing testing and validation is on the challenging cross-border scenarios for barge/vehicles/trucks sailing/driving between Belgium and the Netherlands, thereby testing and validating the impact of enhancements on the 5G SA roaming on achieving the service continuity for cross-border teleoperation. In addition, more tests with higher traffic load (e.g., multiple camera feeds), and various weather conditions, are planned.

#### Vertical use cases addressed in 5G PPP

##### Automotive, Transport and logistics

## 5GMED

### Sustainable 5G Deployment model for future mobility in the Mediterranean cross-border corridor

*Coordinated by Jose Lopez Luque (Cellnex)*

*September 2020-September 2024*

*Website: [www.5gmed.eu](http://www.5gmed.eu)*

*Twitter: @5GMED\_EU*

#### Objectives

The 5GMED Project aims to bring a sustainable 5G deployment model for future mobility in the Mediterranean Cross-Border Corridor.

5GMED will demonstrate advanced Cooperative Connected, and Automated Mobility (CCAM) and Future Railway Mobile Communications System services (FRMCS) along the "Figueres Perpignan" cross-border corridor between Spain and France, enabled by a multi-stakeholder compute and network infrastructure deployed by MNOs, neutral hosts, and road and rail operators, based on 5G.

The main target of the 5GMED project is to design a common roads/railways 5G infrastructure architecture, with proven sustainable business

models, demonstrated investment viability and scalability potential.

The architecture will be suited by design to pervasively respond to both CCAM and FRMCS functional requirements, with cross-border, shared, and secured services' functional continuity.

#### Major results and innovations

5GMED aims to design a network architecture to meet the strict performance requirements of the use cases in terms of service end-to-end latency, data-rate, reliability, and mobility interruption time. This architecture is composed of three strata: (i) infrastructure, (ii) functional, and (iii) management and orchestration.

The infrastructure stratum is designed to provide seamless high-quality connectivity and



includes all the interconnection links and equipment. It is divided into four parts: access network, transport network, MEC, and Cloud. The access network is mainly based on two experimental 5G SA networks (one in Spain and one in France), consisting of a 5G NR Radio Access Network (RAN) and a 5G-core network (3GPP Release 16). Both 5G SA networks provide 5G coverage on the E-15 highway and rail track along the cross-border corridor. In order to show how such architecture can be deployed in real-life scenarios including 5G connectivity gaps, the 5GMED infrastructure also integrates other radio access technologies (RAT): C-V2X (PC5 interface) roadside units on the highway, and 70 GHz IEEE 802.11ad access points and satellite connectivity on the rail track. In order to ensure seamless connectivity, the 5GMED consortium is also developing a multi-connectivity unit that facilitates the handover between 5G NR and the other RATs. In addition, the 5G-cores will be configured to minimize service interruption times during cross-border roaming. The transport network consists of fibre optics, microwave, and satellite links.

The functional stratum includes the core functionalities of the network architecture, and namely the network slicing technology used to provide resources and ensure the QoS to the different use cases.

Finally, the management and orchestration stratum includes a network management and service orchestration platform, as well as the necessary software tools that collect data from the network and feed it to autonomous AI functions to (re-)optimize the network configuration.

**Description of demos, trials and use cases**

5GMED defined four use cases to capture the challenges related to both CCAM and FRMCS, namely, 1) remote driving, 2) road infrastructure digitalisation, 3) future railways mobile communications, and 4) follow-me infotainment. The validation of these use cases is expected to lead to interesting insights and recommendations that can be valid for future deployment of other use cases. The following subsections describe the main aspects and challenges of the use cases.

**Use case 1 Remote driving**

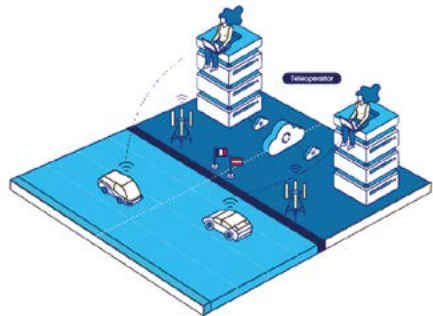

*Fig. 31: Use case Remote driving*

The objective of the remote driving use case is to provide remote assistance to an autonomous vehicle that encounters a complex road traffic situation, e.g., accident, bad weather conditions, etc. When this happens, the vehicle decides to autonomously stop on the emergency lane and to make a request for remote assistance to the teleoperation centre. Next, a remote driver teleoperates the vehicle until it reaches a safe position to continue driving. During teleoperation, video images and data from vehicle’s sensors (e.g., 360° camera, LIDAR) must be perceived by the remote driver with sufficient quality and short delay, and the actuators of the vehicle must execute commands reliably and with low latency to provide full control to the remote driver.

**Use case 2 Road Infrastructure Digitalisation**

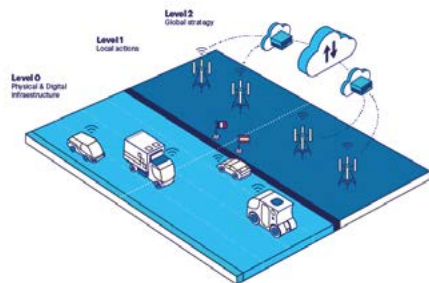

*Fig. 32: Use case Road Infrastructure Digitalisation*



The objective of the road infrastructure digitalisation use case is to ensure safe and efficient mobility in highways with mixed traffic where connected vehicles coexist with nonconnected vehicles. A Traffic Management Centre (TMC) executes intelligent traffic management strategies by processing the information received from vehicles and from roadside sensors. Two types of strategies are considered: (i) warning traffic strategies, and (ii) global traffic strategies. Warning traffic strategies focus on the detection of hazardous events (e.g., stopped vehicle, traffic jam, etc.) and real-time warning notifications from the TMC to vehicles approaching to the risk area. These events can be detected by vehicles' on-board sensors or by cameras on the infrastructure. In global traffic strategies, the TMC analyses the traffic situation to detect abnormal behaviours, devises a traffic strategy, and finally sends regulation commands to groups of vehicles, e.g., change lane or adjust speed.

**Use case 3 Future Railway Mobile Communications**

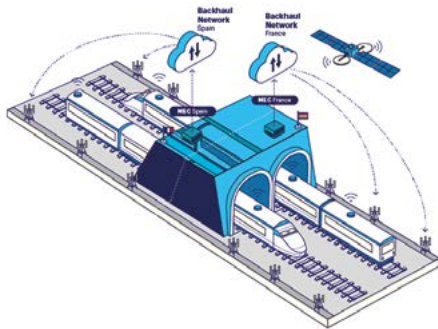

Fig. 33: Use case Future Railway Mobile Communications

The FRMCS use case of 5GMED includes the following performance and business services [3]: (i) massive on-board sensors monitoring, to monitor the status of non-critical systems of the train by transmitting sensors' readings to the train's control centre; (ii) railway track safety, to detect hazards on the rail tracks by using LIDAR on-board and AI processing on the MEC;

(iii) passenger safety and comfort, to detect dangerous situations on-board (e.g., fire, fights) using cameras on-board and AI processing on the MEC; (iv) high-quality Wi-Fi connectivity for passengers; and (v) Multi-tenant Mobile Service that use 5G small cells on-board the train to provide high-bandwidth & low-latency access to a MNO service.

**Use case 4 Follow-ME Infotainment**

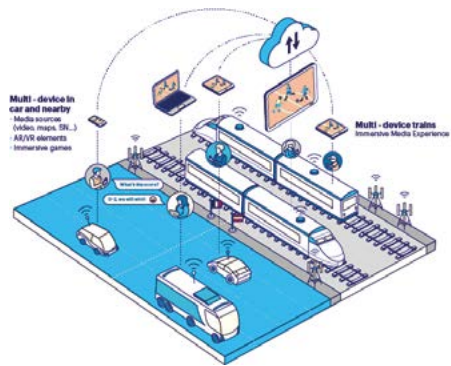

Fig. 34: Use case Follow ME Infotainment

The aim of the follow-me infotainment use case is to distribute several types of high-quality media contents, such as live-streaming of 360° video, video-conferencing, and virtual reality video, synchronously to passengers travelling at high speed by car or train. It consists of moving the virtual functions of the media services across different MEC nodes as the user moves along the cross-border corridor, so that these virtual functions are located close to the user's position at all times, following the user's movements. This ensures very low-latency and high data-rate at all times, yet it poses a challenge in terms of service continuity at the cross-border since media services must be provided without interruptions.

**Vertical use cases addressed in 5G PPP**

**Automotive, Energy, Media and Entertainment, Public safety, Smart cities and utilities, Transport and logistics**

Coordinated by Kristijan Kuhl (Ericsson)

September 2020-August 2024

Website: 5g-routes.eu

Twitter: @5GRoutes

## Objectives

The overall objective of the 5G-ROUTES project is to conduct advanced field trials of some representative and innovative CAM applications, seamlessly functioning across a designated 5G cross-border corridor ('Via Baltica-North') traversing Finland, Estonia & Latvia, in order to validate features and 3GPP specifications under realistic conditions, so as to accelerate the widespread deployment of 5G end-to-end (E2E) interoperable CAM ecosystems and services in digitised motorways and shipways throughout Europe. For this purpose, a number of use cases have been identified in the 5G-ROUTES project<sup>33</sup>. Among these, four specific use cases

focus on the quality and coverage of connectivity services in maritime scenarios, which are the focus of this report. Two of these use cases focus on passenger infotainment services, one focuses on supply chain and freight transparency in multimodal transportation and one focuses on smart ferry/vessel itself.

## Description of demos, trials and use cases

In relation to the general goals defined in the previous section, one of the challenges currently being addressed in the 5G-ROUTES project include aspects related to the deployment, testing and trialling of actual mobile networks endowed with a satellite component and multi-hop technology in maritime environments to guarantee seamless 5G connectivity in the Baltic Sea.

33. 5G-ROUTES D1.1 "Use cases, scenarios, specifications and target KPIs for 5G for CAM v1.0", Dec. 2020

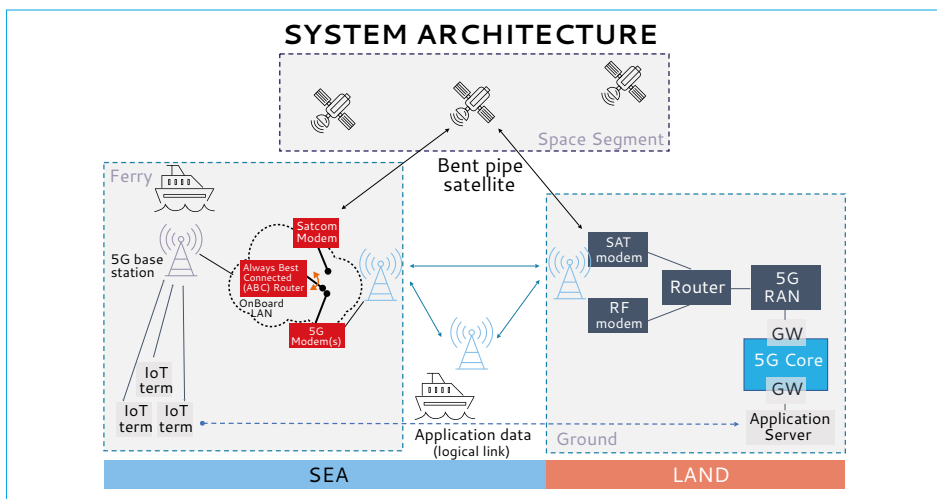

Fig. 35: Overview of the trial architecture

In 5G-ROUTES, trials are planned in the Muuga/Tallinn (Estonia) – Vuosaari/Helsinki (Finland) corridor. The plan is to utilize Eckerö Line's Finbo vessels as test platforms and equip them with

the necessary radio and communication devices. Maritime use cases will utilize 700 MHz, 3.5 GHz, and satellite communication as backbone and ferry coverage. These scenarios will



be extended with multi-hop connections: By creating a “dynamic” 5G mesh network in the corridors of intensive vessel traffic, it is possible to provide backup channels for ensuring 5G connectivity. In cases where one connection channel is lost, vessel connects to another vessel without losing a connectivity. All these solutions will be tested and analysed both separately and together in a real maritime operation environment.

The architecture of the maritime trials is displayed in Figure 35. The installed infrastructure consists of a number of onshore 5G base stations in the port of Muuga (Estonia) and onboard 5G systems. This could allow evaluations in the port areas and the ferry route between Estonia and Helsinki Finland to validate the use cases listed in the section above and providing uninterrupted connectivity.

The planned trials include the implementation and use of Non-Public Networks (NPN) networks on the vessels, i.e., a self-confined 5G network is deployed onboard. This is out of practical considerations, as a stable and performant ship-to-shore connection is part of the research and evaluation tasks within the 5G-ROUTES project. Having the core control plane or the whole core onshore can lead to failure of the entire network, making trials focusing on user plane performance difficult. From economic perspective, it makes sense to minimize the amount of components on the ship while still keeping the option to deploy backend application to MEC-hosts. This corresponds to the network split option where a centralised control plane core is deployed onshore with a decentralised user space core (UPF) onboard for MEC access. By deploying the whole core onboard for trials, the project will also be able to finally answer the question if, and under which circumstances, it would be possible to use an onshore, centralised, control plane core. To prepare for the first phase of connectivity trials, a 5G private

network provided by Ericsson has been deployed in a test lab located in Latvia, as it can be seen in Figure 36. The solution provides all the necessary 5G functionality, it is very compact and quick to deploy onboard the vessels.

In a multi-hop network, increased number of hops, the distance between vessels, used frequency for backhaul, limited nodes resources due to congestion and other aspects have a clear impact on Quality of Service (QoS). Accordingly, in the planned trials, measurements of latency, throughput and signal-to-noise ratio will be carried out to identify and validate assumptions about factors affecting the provided QoS.

The time frame of the execution of the 5G-ROUTES project will not allow sufficient study of the future standard implementations of Release 17<sup>34</sup>, but will give a benchmark for future extended 5G coverage trials in measurements of hybrid backhaul solutions with current cellular and satellite technologies. Nevertheless, the need for improved coverage and cellular 5G service will be verified by the piloting ferry operator and the 5G-ROUTES use cases. Additional information can be found in the “Seamless 5G Multi-hop Connectivity Architecture and Trials for Maritime Applications” paper<sup>35</sup>.



Fig. 36: 5G private network Core and baseband unit

34. 3GPP “Integrated access and backhaul radio transmission and reception (Release 17); 3GPP TS 38.174 V17.1.0 (2022-06).

35. A. Lindenberg, M. Muehleisen, M. Payaró, K. Kärbe Kaare, H. V. Zaglauer, J. Scholliers, A. Sadam, K. Kuhl, L. Nykanen, “Seamless 5G Multi-hop Connectivity Architecture and Trials for Maritime Applications”, submitted to Sensors – Special Issue on “Recent advances in Mobile and Wireless Communication Networks”, Feb. 2023.



## 5G for the Future Railway Mobile Communication System

Coordinated by Sophie Serodan (UIC)

November 2020–April 2024

Website: [www.5GRAIL.eu/](http://www.5GRAIL.eu/)

Twitter @5Grail

### Objectives

5GRAIL<sup>36</sup> is a project funded by the Directorate-General for Communications Networks, Content and Technology (DG Connect) under the 5G for Connected and Automated Mobility (CAM) Programme. It was launched on 1 November 2020, with 18 partners contributing from 11 countries of the European Union, representing the telecom industry, railway operators and universities. The Future Railway Mobile Communication System (FRMCS), which is being specified and implemented as a standard, combining 5G transport with Mission Critical (MC) features, will be vital in triggering the widespread digitalisation of the rail sector. Therefore, it is one of the major, if not the major “game changer” in DG MOVE’s strategy to develop the railway Command–Control System.

FRMCS will be the global 5G standard for railway operation communications, conforming to European regulations as well as responding to the needs and obligations of rail organisations outside of Europe.

5G FRMCS being deployed will allow railway operators to implement a non-limited list of new applications to, on the one hand, optimise train operations and maintenance, and, on the other, to increase the quality of service to passengers (security, availability, punctuality and information).

As part of the FRMCS readiness initiative, 5GRAIL aims to:

- i. Develop Test Cases and evaluation criteria
- ii. Develop the TOBA (Telecom On-board Prototype)
- iii. Give the green light to the first set of FRMCS specifications by developing and testing on-board and application prototypes, both in lab and field environments

- iv. Provide feedback and analysis to specification organisations for consideration in the FRMCS specification updates.

The lab and field pilot tests have been launched across various European sites (France, Hungary, and Germany), in order to ensure compliance and verify the FRMCS v1 specification, an important step in the process to enable the time-to-market from 2025/2026 for FRMCS products.

### Major results and innovations

In 2021 and 2022, the project partners recorded notable achievements by developing a test plan with more than 114 lab test cases, verifying the on-board FRMCS (OBapp) and the trackside (TSapp) interfaces for compatibility with Mission Critical (MC) “loose coupled” data applications including:

- Automatic Train Protection (ATP)
- Automatic Train Operation (ATO)
- MCPTT (Mission Critical Push-to-Talk) tight coupled (voice communications)
- The Train Control Management System (TCMS)
- The Passenger Information System (PIS)
- Closed Circuit Television (CCTV)
- Video

The EC have recognised the following 5GRail activities as innovations, and published them on the Innovation Radar’s public website:

- Cybersecurity architecture for the MC over 5G ATO application;
- 5G FRMCS – GSM-R interworking;
- FRMCS tailor-made 5G Module (1900 – 1910 MHz TDD).

Functional test cases were released for a preliminary R17 Railway Emergency Call (voice), as well as cross-border scenarios for TCMS, ATP (ETCS), bearer flexible feature validation

36. [www.5GRAIL.eu](http://www.5GRAIL.eu)





using CCTV, ATP (ETCS) and ATO applications. Moreover, Key Performance Indicators (KPIs) and Quality of Service (QoS) elements regarding application were introduced in the test plan's descriptions to compare performance in perfect and degraded conditions.

The FRMCS On-Board System (TOBA) prototype architecture has now achieved a good maturity level, with the 3GPP Mission Critical and FRMCS On-Board application interface (OBAPP) requirements also being considered. The first TOBA prototype has been built and is already supporting lab testing, and a second one has been made available. It includes a tailor-made FRMCS modem prototype, supporting the FRMCS 1900MHz TDD band in 31dBm (as per ECC (10) 02 Decision), and they are currently under in-lab testing and will also be used in the field. The TOBA prototype includes up to 4 internal modems, for resource sharing and bearer flexibility, 4G, Wi-Fi, and n8, n78, all of which have been used in lab scenarios. The n39 and n78 5G bands will also be tested on both French and German testbeds.

The labs in Hungary and France are fully operational, offering a complete 5G SA infrastructure, IMS, MCX services, and also with other 5G bearers (for bearer flexible use cases), which are available for testing specific FRMCS applications. Applications provided by 5GRAIL partners have already been integrated and installed, or are available remotely in both labs.

Voice, REC, ETCS, TCMS, CCTV, and video testing is ongoing in the Hungarian lab, alongside further integration testing of enhanced use cases for border crossing, GSM-R voice interworking, and bearer flexibility. The lab in France is performing functional testing with ETCS, ATO, Remote Vision and PIS applications is making good progress and a cybersecurity demonstration is also being studied.

Another achievement relates to field testing, which preparing started in January 2022. The functional field tests (to be repeated from Lab tests) have already been specified with the work on on-site readiness by 2023 continuing.

Lastly, the emulation of the road and rail co-existence scenarios have been analysed. From the civil engineering point of view, the main co-existence scenarios that have been considered are the tracks parallel to roads, tracks crossing roads, tunnels and bridges. From the telecommunications point of view, different network architectures were considered (shared/isolated core network, shared/isolated access network, etc.) as well as different innovative technologies (Edge Computing, SDN/NFV), different RATs (4G/5G, Wi-Fi) and new use cases (automated vehicles, remote driving). All these elements have been combined to define a simulation/emulation platform for performance evaluation in a rail/road coexistence context: Emu5GNet1.

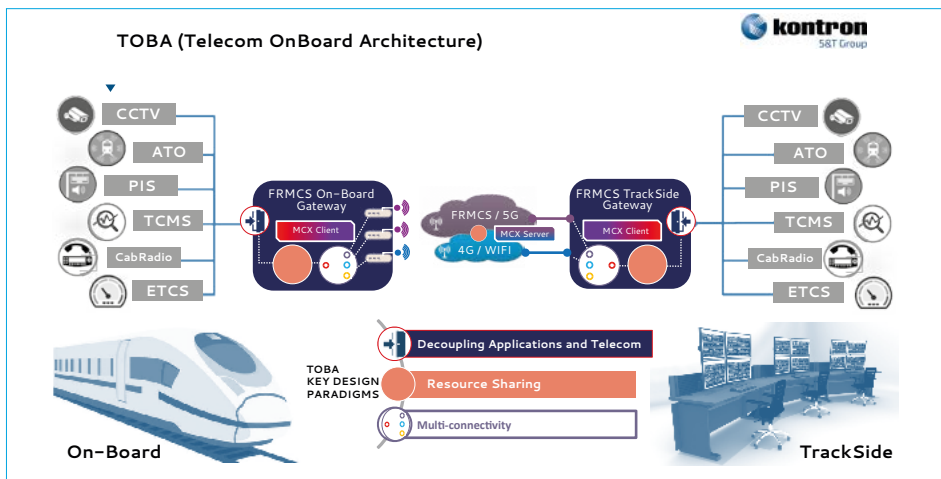

Fig. 37: TOBA: Telecom Onboard Architecture



### Description of demos and/or trials

Work on implementation and evaluation in the field aims to provide a 5G railway field test environment to evaluate the technical solutions and the prototypes developed within the project and to demonstrate the usability of 5G FRMCS as a solution to the needs of railway applications.

The tests will be performed in parallel in two sites, one in France and one in Germany, each with different characteristics in terms of architecture and test cases. Cross-border use cases will also be performed to compare the results in different conditions.

The planning phase has started for both test sites, regularly coordinating with the different partners involved in the test beds, especially for installing the network, and for the applications. In the meantime, a test bed assumptions list has been compiled, and the test cases list has been reviewed regarding field implementation.

### Verticals use cases addressed in 5G PPP

#### Transport and logistics

# 5G PPP PHASE 3, PART 6: INNOVATIONS FOR VERTICALS WITH THIRD PARTY SERVICES

The nine projects<sup>37</sup> from H2020-ICT-41-2020: 5G innovations for verticals with third-party services started in January 2021.

37. <https://5g-ppp.eu/5g-ppp-phase-3-6-projects/>

## 5GASP

### 5G Application & Services experimentation and certification Platform

Coordinated by Diogo Nuno Pereira Gomes (ITAv)

January 2021-December 2023

Website: [www.5gasp.eu/](http://www.5gasp.eu/)

Twitter: @5gasp

#### Objectives

Mobile communication technologies have been evolving unprecedentedly fast with 5G.

This fast pace requires stable testing and validation environments for developing 5G applications and services. In this scope, project 5GASP provides tools and testbeds for SMEs developing, testing, and certifying 5G applications and services, moving from concepts to prototypes and eventually products. However, industrial verticals have diverse needs, considering the cases of Automotive and Public Protection and Disaster Relief (PPDR), requiring different levels of support in realising prototypes.

Given this context, 5GASP targets shortening the idea-to-market process through the creation of a fully automated, self-service testbed fostering the rapid development and testing of innovative Network Applications built under the 5G NFV-based reference architecture. Leveraging existing physical infrastructures, 5GASP focuses on automated and innovative

experimental test operations across several countries and domains, providing support tools for Virtual Network Function (VNF) Continuous Integration and Continuous Deployment (CI/CD) in a secure & trusted environment for companies capitalising on 5G. 5GASP targets the creation of an Open-Source Software (OSS) repository and a VNF marketplace targeting SMEs with OSS examples and building blocks, as well as incubating a community of NetApp developers supported by tools and services enabling an early validation and/or 5G NetApp certification.

#### Major results and innovations

5GASP has already achieved several milestones, either through contributions to the standardisation of the Network Application concept, software tools to assist testbeds and experimenters, or NetApp examples created by the project SME's:

- Network Application requirements and 5GASP's approach at 5G PPP Software Network WG<sup>38</sup>
- Complete OSS platform for onboarding, deployment and testing Network Applications over 5G infrastructure (Openslice)<sup>39</sup>
- Interdomain Network Orchestrator (NetOr) [2] · Virtual On-Board Unit provisioning NetApp (vOBU)

38. <https://5g-ppp.eu/wp-content/uploads/2022/10/Software-Network-WG-Network-Applications-2022.pdf>

39. <https://www.innoradar.eu/resultbykeyword/5gas>



- Virtual RoadSide Unit provisioning (vRSU) · Cooperative Intelligent Transport Systems Station (C-ITS-S) over 5G infrastructure
- Multi-domain Migration Service for MEC Services
- Vehicle-to-Cloud (V2C) Real-Time Communication · Remote Human Driving NetApp – Teleoperation for assisting vehicles in complex situations · Efficient Resource Handover Prediction in Mobile Edge Computing (MEC)
- A Machine-Learning based Privacy Analysis Cloud Native Software for 5G environments (PrivacyAnalyser) · Implementation of IOPS (Isolated Operation for Public Safety) for 5G network · Demand responsive transportation platform over 5G infrastructure · Fire detection and ground assistance using drones (FIDEGAD)
- Automated Certification for 5G NetApp in O-Ran ecosystems.

The design and development of network applications is a key phase in the 5GASP workflow, as this is where the majority of the effort of SMEs is focused. Besides providing a NetApp oriented development platform, testing and validating tools, 5GASP created a set of exemplary use cases to be used first as a showcase to prove that our platform works as expected and second,

to collect principles, lessons learned, and good practices in the processes of onboarding, developing, testing, validation, and certification of network applications which will definitely help future network applications developers to accelerate the whole process of producing network applications .

5GASP offers NetApp developers the opportunity of deploying and certifying their network applications in a real 5G network through its provided services. The experimenters can take advantage of the fully automated 5GASP framework that enables the automatic onboarding, deployment, testing, and certification of network applications in a controlled environment, in which real-world conditions of the network can be provided to validate the operation and behaviour of the NetApp in a secure way. Once certified, the NetApp developers can be sure that their solutions can be effectively deployed in the 5G world.

### Description of demos, trials and use cases

5GASP takes in developers' requirements along with the provision of seamless onboarding, deployment, and testing processes through an interconnected reference ecosystem of experimental facilities as depicted in our high-level system architecture (Figure 38).

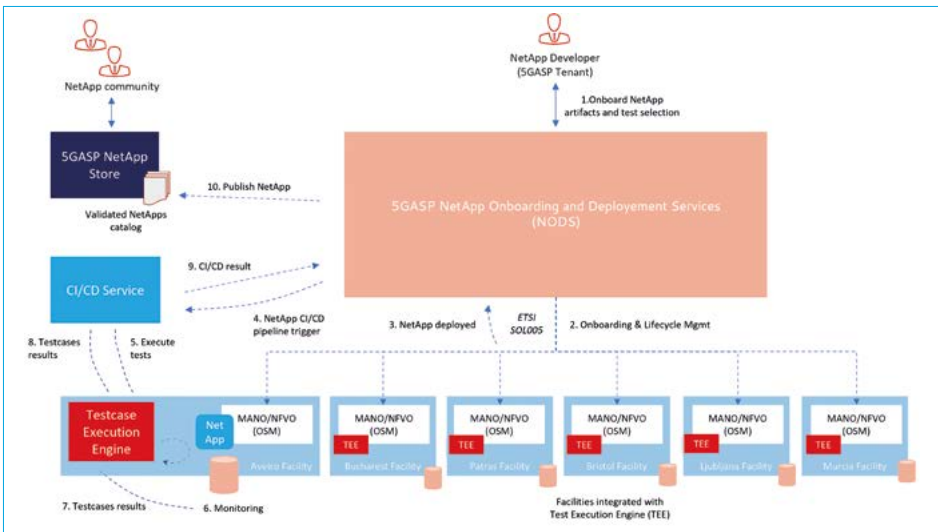

Fig. 38: 5GASP Architecture

Developers get access to 5GASP through a user-friendly portal solution that supports the uploading of NetApp's NFV artifacts, the onboarding of the latter to relevant experimental facilities, and the selection of predefined test suites or the design of custom ones to be executed against the onboarded NetApp (step 1). 5GASP NetApp Onboarding and Deployment Services (NODS) are the entry point to the system, providing a Service Order Management (SOM) component and offering its own Service and Network Orchestrator that coordinates actions throughout the underlying facilities or other NFV/3GPP compliant systems. From NODS the testing pipeline can be activated for the network applications' validation and certification

processes. Successful validation of a NetApp can grant a public appearance in the network applications Store.

The 5GASP framework provides both pre-defined and developer-defined tests. Pre-defined tests cover multiple aspects of the network applications operation within the 5G ecosystem, such as compliance with the 5G standards, a basic suite of security tests to avoid any inappropriate use of the network, and to check the scalability of the solution. In addition to these, developers are invited to submit their own vertical oriented tests.

#### Vertical use cases addressed in 5G PPP

##### Automotive, Public safety

## 5G-EPICENTRE

### 5G Application & Services experimentation and certification Platform

*Coordinated by Alain Dubois (Airbus)*

*January 2021-December 2024*

*Website: [5gepicentre.eu](http://5gepicentre.eu)*

*Twitter: [@5Epicentre](https://twitter.com/5Epicentre)*

#### Objectives

European SMEs that seek to conduct rigorous experimentation of their products and apps targeted at the public safety market often face several challenges. The 5G-EPICENTRE project intends to minimise barriers to 5G adoption and market entry for by providing an open, federated, end-to-end experimentation facility for such SMEs.

When concluded, the 5G-EPICENTRE will offer an open, end-to-end 5G experimentation platform with a focus on software solutions for Public Protection and Disaster Relief (PPDR). The envisioned platform will give SMEs and developers access to the most recent 5G applications, good practices for first responders, crisis management approaches and the ability to create and test their own solutions. The 5G-EPICENTRE platform is based on an open Service oriented Architecture, adhering to the

most recent best DevOps practices (containerisation of micro-services), and able to offer open access to 5G networks' resources, acting as a 5G open-source repository for PPDR Network Applications.

The 5G-EPICENTRE objectives are:

- Build an end-to-end 5G experimentation platform specifically tailored to the needs of the public safety and emergency response market players.
- Pilot 5G systems in PPDR-based trials, successfully demonstrating 5G-EPICENTRE onboarded apps as a crucial communications accompaniment to public safety mission critical communications technologies.
- Cultivate a '5G Experiments as a Service' model, which will enable developers and SMEs to experiment with PPDR applications in

parameterised, easily repeatable, and shareable environments.

- Facilitate automation, continuous deployment and multi-access edge computing supported by containerised network functions, so as to reduce service creation time and time-to-market for 5G solutions.
- Leverage Artificial Intelligence for achieving cognitive experiment coordination and lifecycle management, including dynamic 5G slicing, application awareness and insightful ML-driven analytics.
- Implement impact-driven dissemination, standardisation, and exploitation.

### Use cases

Experimentation in the context of several first-party experiments (for example, experiments implemented by consortium partners) is ongoing for the evaluation of the 5G-EPICENTRE platform and is realised as a PPDR vertical. This pilot studies' target is to broaden over all three of the 3 ITU-defined service types (i.e., eMBB, mMTC and URLLC), while offering the means to monitor the platform's secure interoperability capabilities outside the scope of vendor-specific implementations. In the light of this, 5G-EPICENTRE has engaged SMEs and organisations, that will take part in the implementation of the use cases and are active participants in the public security and disaster management markets, serving as crucial facilitators for the evaluation of 5G-EPICENTRE with regard to the actual needs that should be addressed. Finally, KPIs related to 5G are measured through the execution of these first-party experiments, particularly those that relate to the creation time of services.

With a series of first-party experimentation activities, each provided by a consortium member, to serve as piloting activities for the platform, 5G-EPICENTRE seeks to address various PPDR operating scenarios. Ingredients from each solution is turned into CNFs/VNFs for each use case and delivered to the 5G-EPICENTRE facilities' orchestration environment. The main objective is to credibly demonstrate a facility that is open enough to offer the network functions required for PPDR applications. This method makes it easier to test important technologies like network slicing and ultra-reliable low latency connectivity. Each partner then documents their individual deployment experience in a VNF environment, the development of the VNFs,

challenges with orchestration, market readiness, and demonstration outcomes. The following are references of the Use Cases envisioned as the first-party experiments:

- **UC 01: Multimedia MC Communication and Collaboration Platform.** The 5G-EPICENTRE platform is used to experiment with a Mission Critical Multimedia and Collaboration platform and Mission Management applications and integrate them with project partners applications or engaged SMEs applications.
- **UC 02: Multi-agency and multi-deployment mission critical communications and dynamic service scaling.** To provide common coordination between first responders under standard 3GPP MCS communications and scaling mechanisms to deal with resource deficiencies.
- **UC 03: Ultra-reliable drone navigation and remote control.** Demonstration of super reliable drone navigation and remote control by utilising the federated testbed resources. Efficient means of controlling drones via voice channels in the mobile network is deployed in the form of VNFs on top of the 5G-EPICENTRE platform facilitating a two-way communication.
- **UC 04: IoT for improving first responders' situational awareness and safety.** A situational awareness platform is used to meet the pre-set goal of aiding C&C Centres to obtain a full awareness of field operations. This includes monitoring of agents in the field through a set of geographical/indoor positioning, environmental and wearable biological sensors, as well as real time text, audio, and video transmissions.
- **UC 05: Wearable, mobile, point-of-view, wireless video service delivery.** Experiment with wearable point-of-view (POV), wireless video in two distinct EMS scenarios, to increase efficiency and accelerate time to treatment by more rapidly characterising acute pre-hospital situations
- **UC 06: Fast situational awareness and near real-time disaster mapping.** System for a range of emergency services using AI to analyse, enhance and extract individually determined datasets for PPDR. Creation of an app and associated hardware for using the 5G

infrastructure via the defined NetApp developer interfaces, are ongoing.

- **UC 07: AR and AI wearable electronics for PPDR.** Real-time semantic segmentation, instance segmentation and edge detection is used to overlay useful information directly on top of the real world through the optical see-through display worn by police officers, who patrol or operate in a designated area.

- **UC 08: AR-assisted emergency surgical care.** Experiment with holographic AR technology for emergency medical surgery teams, by overlaying deformable medical models directly on top of the patient body parts, effectively enabling surgeons to see inside (visualising bones, blood vessels etc.) and perform surgical actions following step-by-step instructions.

#### Vertical use cases addressed in 5G PPP

##### Public safety

## 5G-ERA

### 5G Enhanced Robot Autonomy

*Coordinated by Rafael Lopez (Robotnik Automation SLL)*

*January 2021-June 2024*

*Website: [www.5g-era.eu](http://www.5g-era.eu)*

*Twitter: @5g\_era*

#### Overview and approach

5G-ERA is oriented towards a user-centric paradigm of integrating vertical knowledge into the existing standardised 5G testing framework to improve Quality of Experience (QoE). The project addresses the new challenges on experimental facilities for the vertical developers and designers through the following activities: 1) integrating operational processes of essential autonomous robotic capabilities into Open Source MANO (OSM), ensuring the vertical specific adaptation of existing experimentation facilities, 2) realising an intent-based networking paradigm by aligning the end-to-end (E2E) resource optimisation with the autonomous operations, ensuring effective policy to be designed 3) Cloud native Network Services (NSs) on the experimental facilities will create, ensuring robotic applications exploiting NFV/SDN infrastructures efficiently, 4) extending the experimentation facilities into robotic domains through standard APIs under Robot Operating System (ROS), prompting third-parties' experimentation activities as well as engagement from new players. The emphasis of 5G-ERA on 5G technologies to produce a solution to the long-standing problem of autonomous robotics, leading diverse applications of robots to particularly

the innovative and yet challenging areas such as automated mobility, health and Industry 4.0, and hence contributing to the European economy.

Fundamental to the 5G-ERA is the implementation of a reliable communication layer capable of dealing with collective intelligence, dense data, variety of information and real-time intervention in future autonomous robots. It maps the robotic concept of autonomy into networking objective of quality of experience. 5G promises to be a key enabler for robotic vertical applications with enhanced autonomy. It will not only deliver an evolution of mobile broadband networks; it will provide the unified communication platform needed to disrupt with new business models and to overcome the shortcomings of current communication technologies. As such, 5G technologies have the potential to amplify and accelerate the ongoing transformation, and to unlock a next level of efficiency gains in robotics even for the vast community of European manufacturing SME.

5G-ERA utilises experiences gained from 5G PPP Phase 1, Phase 2 and Phase 3.1 into innovative vertical solutions. Build on top of ETSI OSM, the 5G-ERA intent-based networking, cloud naive reference design and standardised



APIs, enable the interoperability and security to be shared by network applications which following the reference design across the targeted vertical applications. The capability will be verified in field trials using standardised testbeds with NFV. It leads to the latest progress on ML and AI to be used for automatic configuration/decomposition/mapping of network applications on existing experimental infrastructure. 5G-ERA network applications, including 5G-ERA middleware, reference NetApp, and vertical specific network applications will be open source to encourage the reusability of project results. Detailed examples with tutorials will be provided to maximum engagement from all players, especially from robotic platform developers and vertical end users.

### Description of demos, trials and use cases

The project will verify and validate by 5G PPP KPI "Service creation time in minutes" through application driven network optimisation. KPIs have

been sketched for all use cases. Performance optimisation will be showcased in different vertical sectors to ensure the repeatability of the project approach. Within the project period, four new network applications which are specifically designed for PPDR (public protection and disaster relief), transport, logistical robots (in hospital), and manufacturing process will be validated and showcased in three existing testbeds (Greece, Spain and U.K.). All testbeds were built from previous 5GPP projects and national projects. These NetApp solutions will be sharing 5G-ERA progression on enhanced robot autonomy and representing their respective vertical configurations. The 5G-ERA test and validation will open a new window for further development of NetApp in related vertical sectors. In particular, this process will be accelerated in robotic community by the integration of ROS, which is the most commonly use open-source framework for robot software development.

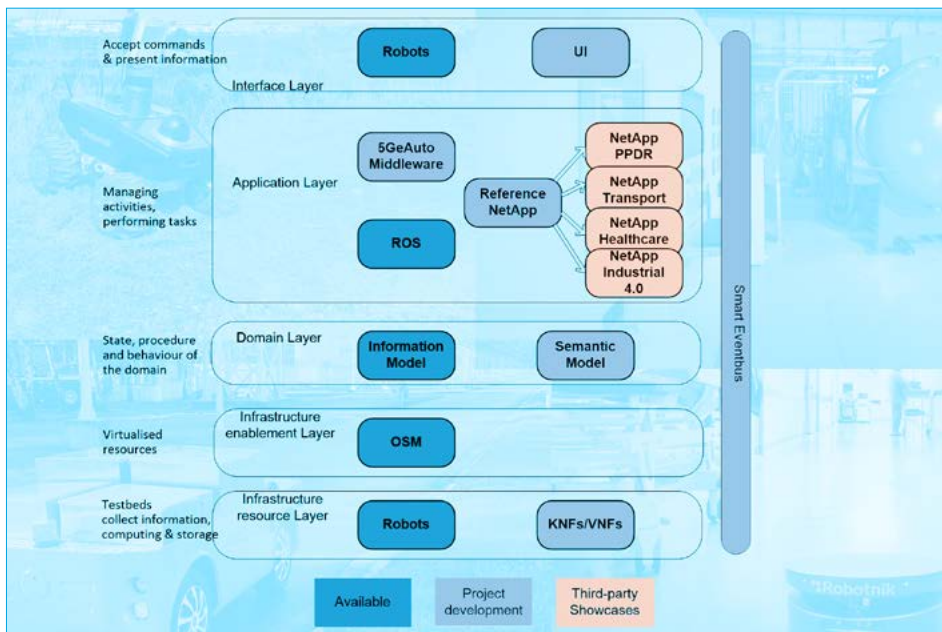

Fig. 39: 5G-ERA architecture and robots

### Vertical use cases addressed in 5G PPP

**eHealth and wellness, Industry 4.0, Public safety, Transport and logistics**



## 5G Intelligent Automotive Network Applications

Coordinated by Angelos Amditis (ICCS)

June 2021-November 2024

Website: [www.5g-iana.eu/](http://www.5g-iana.eu/)

Twitter: @IANA\_5G

### Objectives

5G-IANA aims at providing an open 5G experimentation platform, on top of which third-party experimenters, i.e., SMEs in the Automotive vertical sector will have the opportunity to develop, deploy and test their services. The provided Automotive Open Experimentation Platform (AOEP) is a set of hardware and software resources that provides the computational and communication/transport infrastructure as well as the management and orchestration components, coupled with an enhanced nApp network App) Toolkit tailored to the Automotive sector, for simplifying the design and onboarding of new network applications. 5G-IANA exposes to experimenters secured and standardised Application Programming Interfaces (APIs) for facilitating all the different steps towards the production stage of a new service. 5G-IANA targets different virtualisation technologies integrating different Management and Orchestration (MANO) frameworks for enabling the deployment of end-to-end network services across different segments (vehicles, road infrastructure, Multi-access Edge Computing (MEC) nodes and cloud resources). 5G-IANA network applications toolkit is linked with an Automotive Virtual Network Functions (VNFs) Repository including an extensive portfolio of ready-to-use and openly accessible Automotive-related VNFs and network applications templates, that are available for SMEs to use and develop new applications. Finally, 5G-IANA develops a Distributed Machine Learning (DML) framework, that provides functionalities for simplified management and orchestration of collections of Machine Learning (ML) service components and thus, allows ML-based applications to penetrate the Automotive world, due to its inherent privacy-preserving nature.

5G-IANA aims to:

- Specify and provide an Automotive Open Experimental Platform (AOEP).

- Specify and implement a repository environment for network applications and VNFs to ease the design and chaining of new Automotive-related services.
- Define, implement and trial Connected and Automated Driving relevant Use Cases to validate and assess the AOEP suitability and functional improvements.
- Create new business opportunities and boost market for start-ups and SMEs with Automotive network applications.

### Architecture

The architecture of the 5G-IANA AOEP platform aims to offer service providers mechanisms to easily design distributed intelligent services, which span from the remote cloud to the far-edge segment and request their provisioning on top of 5G-enabled infrastructures. The platform is realised by four main building blocks:

- Network Application Orchestration and Development: the entry point for service providers. It exposes functionalities for designing distributed services composed by network applications. This layer hosts also a catalogue of available network applications that can be used and chained to realize the desired service.
- Slice Management and Resource Orchestration: this layer implements the functionalities for verifying the availability of a network slice instance suitable for supporting the operation of the vertical service. It also handles the orchestration of computational resources to be allocated to run the network applications .
- Data Collection, Monitoring and Analytics: it realizes the collection of data from distributed data sources (i.e., network applications , infrastructure hosts, etc.) and provides analytics based on service-level policies to optimize the Lifecycle Management (LCM) operations.
- DML Orchestration provides explicit support for ML-oriented services, including Federated

Learning (FL) primitives such as client selection and enhanced LCM e.g., drift management.

- The platform allows service providers to wrap all data manipulation processes within network applications that can be reused in broader service chains/graphs. On the one side, the

platform exposes this construct to service providers, allowing them to describe their service. On the other side, the platform interfaces both the 5G System and the available far-edge/UE-side resources/nodes to enable a series of Distributed Machine Learning Orchestration (DMLO) functional primitives.

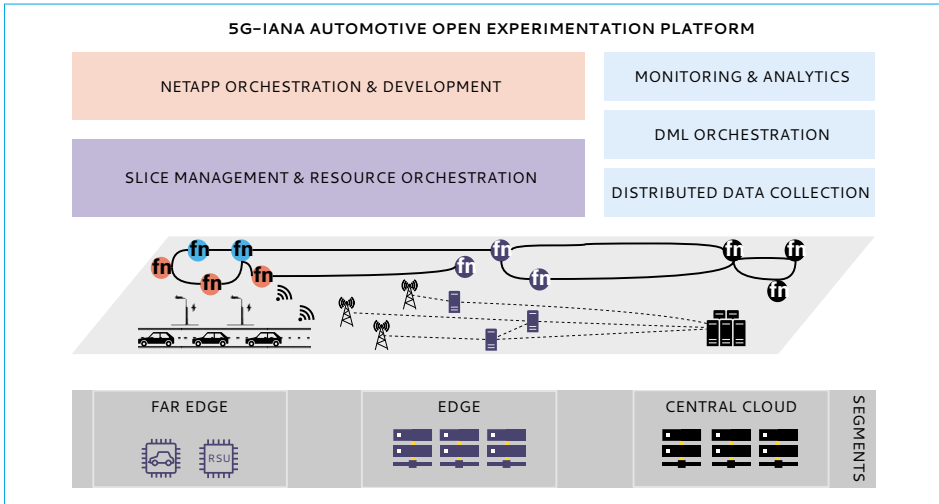

Fig. 40: 5G-IANA Network Application (nApp) Experimentation Platform

### Description of demos, trials and use cases

5G-IANA will be demonstrated through seven Automotive-related use cases in two 5G Stand Alone (SA) testbeds, one in the city of Ulm (operated by NOKIA) and another one in Ljubljana (operated by Telekom Slovenije):

- **UC1 – Remote Driving** is about integrating, demonstrating, and validating advanced remote driving functionalities in the 5G-IANA platform. The aim is to use a vehicle connected through 5G, which is controlled remotely via a teleoperation platform.
- **UC2 – Manoeuvres coordination for autonomous driving** aims to showcase a manoeuvre coordination service, capable of lowering the risk of collision in complex junction scenarios by describing suitable paths and priorities for connected and automated vehicles directed by a shared coordination system.
- **UC3 – Virtual bus tour** will facilitate an immersive virtual bus tour experience for Virtual Reality (VR) headset users. The users select an avatar to represent them in the VR space and

join a guided tour on a double-decker bus. On their Head Mounted Display (HMD), the users receive a video of the tour surroundings, streamed through a high resolution 360° camera, mounted onto the bus, while it performs the “real-life” tour.

- **UC4 – AR content delivery for vehicular networks** aims at providing “high-quality Augmented Reality (AR) content streaming” taking advantage of the future web AR applications, the MEC and 5G connectivity.
- **UC5 – High-risk driving hotspot detection** aims to detect aggressive and distracted driving (hazardous events) and transmit warning notifications on road risk-level to other vehicles. The two kinds of risky behaviour possible to detect are aggressive driving (harsh braking, harsh acceleration, speeding, crashes) and distracted driving (mobile use).

### Vertical use cases addressed in 5G PPP

**Automotive, Media and Entertainment, Public safety**



## Open cooperative 5G experimentation platforms for the industrial sector network applications

Coordinated by Franco Davoli (CNIT)

January 2021-December 2023

Website: [www.5g-induce.eu](http://www.5g-induce.eu)

Twitter: <https://twitter.com/5GINDUCE>

### Objectives

The prime goal of the **5G-INDUCE** project is to develop an end-to-end service orchestration platform over enabling 5G experimentation infrastructures (with specific target in the Industry 4.0 vertical sector) able to provide the essential mechanisms for the onboarding of advanced 5G Network Applications and the efficient management of the infrastructure resources, independently of the underlay network orchestration layer. The aim is to provide the enabling interfacing layer between the vertical sector end-users and the infrastructure owner to

select, deploy and also extend their 5G applications with the appropriate networking features that comply with the application requirements, in terms of physical network constraints (such as bandwidth and latency), as well as functional constraints (such as locality, resiliency, security). Moreover, the 5G-INDUCE platform enables Network Application developers to have a common interface for the porting of their Network Applications, either as complete services (in the form of linked application components) or individual extension components to existing services.

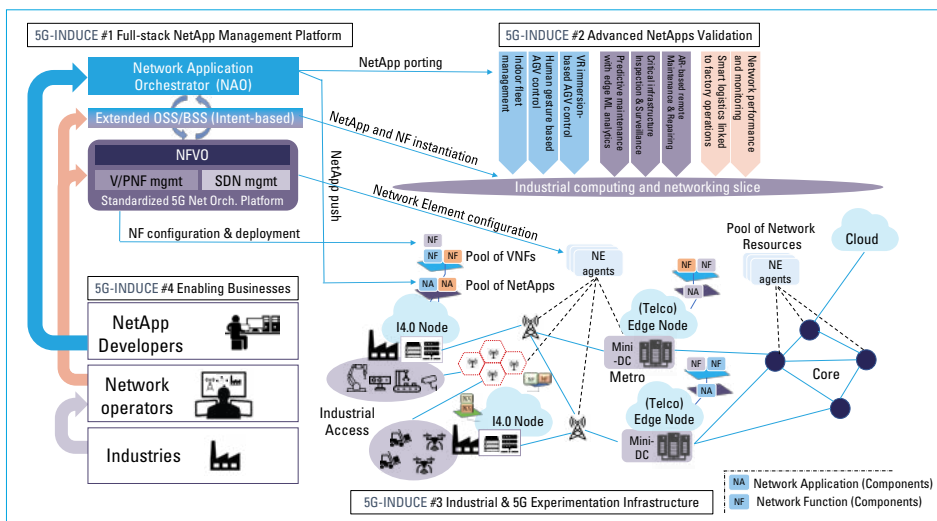

Fig. 41: The 5G-INDUCE vision and the adopted approach for easy (i) porting and/or (ii) development of industry 4.0

To achieve the targeted development goals and also demonstrate successfully the functionality of the 5G-INDUCE platform solution through a number of use cases and over real industrial experimentation facilities, the overall work is split into the following development areas:

**Development Area 1: 5G-INDUCE orchestration platform.** This refers to the main innovation offered by 5G-INDUCE, which provides the end-user driven Network Application onboarding and lifecycle management of the Network Applications over the southbound 5G



infrastructures. The platform is composed by the Network Application Orchestrator (NAO) and the Operations Support System (OSS) modules. The NAO deals with the Network Application onboarding and deployment requests, allowing Network Applications to negotiate and obtain from the OSS both the needed computing resources at the edge facilities where to run Network Application components, and connectivity among such resources and User Equipment (UE). The OSS deals with the tasks of analysing operational and performance (soft and hard) constraints expressed by the NAO slice request and consequently selecting the most suitable computing facilities and network services complying with the requirements. Key innovative features of the platform include:

- the automated translation of Network Application micro-services into deployment requests for the OSS, annotated with QoS and operational requirements,
- the generation of end user- or policy-based requests by the NAO to the OSS for reconfiguration of the deployed resources at run-time (including resource scaling and/or relocation of involved VNFs),
- the capability of the OSS to select/deselect proper resources at edge facilities updating/creating/deleting network services,
- the dynamic reconfiguration of network slices to transparently/smoothly redirect UE incoming/outgoing traffic during the reconfiguration phases,
- the introduction of the NFV Convergence Layer (NFVCL), for driving NFV orchestration along the lifecycle phases over external network orchestrators (e.g., MANO) and through standard interfaces, thus exploiting the programmability level offered by the underlying network infrastructure(s).

**Development Area 2: Use case Network Applications.** This area deals with the developments for the specific use cases envisioned in 5G-INDUCE and more specifically with the development of the essential Network Application components, offered in the form of Kubernetes micro-services, for supporting the targeted use cases. All use case applications are decomposed in a series of linked micro-service components, complying with the Network Application graph approach defined for the NAO part of the platform. Besides the components developed in support of the use cases, the goal is to develop also general-purpose Network Application components that can be directly added to the existing applications and update them or reused by other applications. The design of such Network Applications is critical in order to fully utilise the platform capabilities and then demonstrate real case scenarios over the targeted infrastructures at the industrial sites.

**Development Area 3: Experimentation in- infrastructures.** This area refers to the actual testing infrastructures of the project. Three main experimental infrastructures (ExFas) are considered and located in Spain, Italy and Greece. All ExFas relate to industrial sites and connect to the core network through operator-scale 5G infrastructures. The three sites have been designed to have different deployment characteristics complying with a diverse set of actual deployment scenarios and market directions, including independent industrial 5G infrastructures with 5G support by operators and full network programmability, operator owned 5G infrastructures with Network Application level configuration capabilities, and hybrid schemes of operator supported infrastructures with some programmable features at the industry level. In addition to the ExFas, a DevOps testbed has been developed to host the integration, testing and validation of the platform and the use cases prior to their deployment over the industrial ExFas. The role of the DevOps testbed is important for the integration of the whole developments.

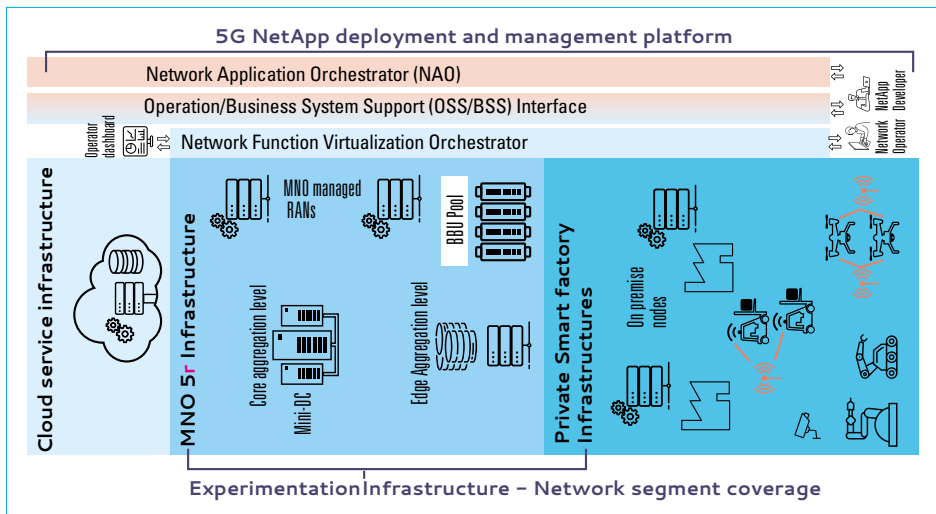

Fig. 42: Main concept depicting the Network Applications Orchestrator (NAO)

## Vertical use cases addressed in 5G PPP

### Industry 4.0

## EVOLVED-5G

### Experimentation and Validation Openness for Longterm evolution of VERTICAL industries (EVOLVED) in 5G era and beyond

Coordinated by Javier Garcia Rodrigo (Telefonica)

January 2021-December 2023

Website: [www.evolved-5g.eu](http://www.evolved-5g.eu)

Twitter: @evolved5g

#### Objectives

With Non-Public 5G Networks (NPN) already emerged, the existing experimentation platforms around Europe should increase the development pace to incorporate realistic business cases for the use of 5G by vertical industries. In this endeavour, the directions provided by 3GPP are considered as an effort to provide verticals with a common ground for upgrading their applications.

A central concept that has emerged is the composition of **network applications** i.e., services that consume 3GPP APIs (native APIs) as well as other telco assets (referring to business support system – BSS APIs, e.g., service orchestration

APIs) to support the vertical application with network-related capabilities. For example, a Network App could consume APIs that provide monitoring events and network slice configuration analysis to compose a service that guarantees quality of experience for latency-sensitive applications.

*EVOLVED-5G embraces the potential of the emerging **Network App ecosystem** under a twofold scope: i) to build an **open experimentation facility for Network App creation, validation, and certification**, and ii) to provide the means and the tools for **long term evolution of 5G-enabled vertical industries**.*



Irrefutably, the Network App ecosystem will be beneficial for multiple and heterogeneous vertical industries. However, at project level, a single industry approach allows for clear contributions and deeper analysis of the expected impact. In view of this, EVOLVED-5G has strategically selected the vertical industry of **smart manufacturing** in the context of the **Factory of the Future (FoF)**.

The objectives of the EVOLVED-5G project are summarised below:

- Upgrade the 5G experimentation potential in Europe, through the design, development, and release of an open 5G experimentation facility that will materialise network programmability and will expose standard 3GPP APIs to enable automated Network App validation tests.
- Materialize the openness of 5G to vertical industries by creating a Network App development and verification environment, i.e., a workspace/SDK for third parties.
- Provide the means for enabling the digital market around the Network Apps by designing, developing, releasing and maintain an active marketplace/App store that will store Network Apps that are certified by operator-driven certification tools.
- Provide a clear and quantified contribution towards the 5G penetration in smart manufacturing by designing, developing, validating, and publishing innovative Network Apps and applications on top of them that will cover use cases for the factories of the future.

- Quantify the performance and the flexibility that 5G provides to verticals, though a set of vertical-driven measurement campaigns, which will use standard reference points (e.g., the CAPIF/NEF), target critical network metrics and feed data a technoeconomic analysis.
- Maximise the technological fingerprint and the business potential expected from the integration of 5G in manufacturing.

### Common API Framework (CAPIF) Implementation

The 3GPP Common API Framework (CAPIF) is considered as one of the cornerstones in the realisation of 5G openness, since it allows secure exposure of 5G core APIs to third party domains, and enables third parties to define and expose their own APIs. Indeed, CAPIF has become already a fundamental feature for the 3GPP SA6, targeting the interaction of various Vertical Industries with the 5G system, including Unmanned Aerial Systems, Edge Applications, Factories of the Future, V2X services, etc. Beyond that, CAPIF can be considered as a standardised API manager in the beyond 5G era that can facilitate any API-based interaction, including for instance federation activities among testbeds and experimentation platforms, east-west interaction among business and orchestration layers, or exposure capabilities that reside at the edge domain (e.g., MEC APIs exposure). An abstract representation of the CAPIF operation is depicted in Figure 43: Abstract illustration of the CAPIF functionality, with representative examples of its applicability

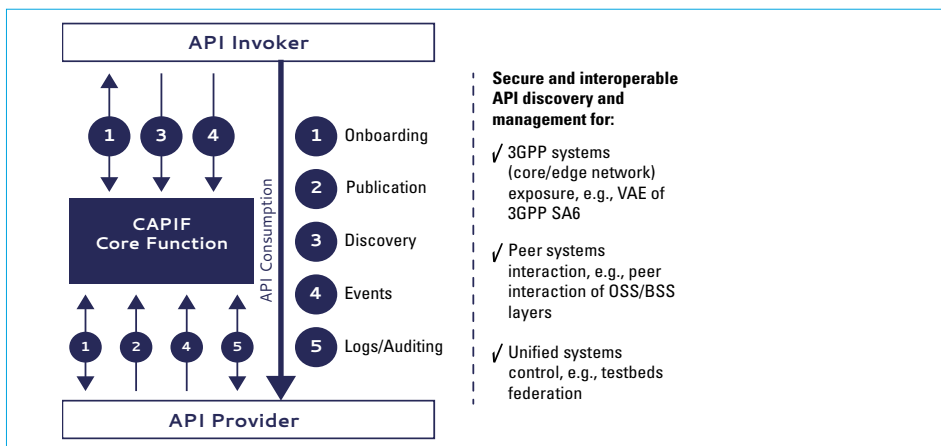

Fig. 43. Abstract illustration of the CAPIF functionality, with representative examples of its applicability

Within EVOLVED-5G project, the Core Function of the CAPIF (namely the CCF) has been developed<sup>40</sup> together with examples for API provider and API invoker that someone can use in order to develop its own API provision/consumer entities. The CCF comes together with a set of automated tests which can be used to validate that an API provider/invoker is 3GPP CAPIF compliant (Rel. 17). The solution is provided under Apache2.0 license and is already listed in the EU Innovation Radar. In the long term, CAPIF implementation can be seen as an accelerator for Vertical Service Providers (VSP), since with a standardised API framework the interoperability is maximised and, thus, the time to market is reduced. Similarly for a network operator, the CAPIF implementation provides a unified, controlled, and secure way for the exposure of various network functions to third parties/VSPs.

### Network Exposure Function (NEF) Emulator

The NEF Emulator<sup>41</sup> is an open experimentation framework that implements NEF APIs on top of a simulated environment, to help evaluate the service APIs that are now available. It consists of three layers: the network layer, the exposure layer, and the management layer. In the network layer the emulated environment helps users to create scenarios that replicate the fundamental elements of a 5G network. For example, service consumers (application developers) can achieve user mobility via predefined paths in the simulated environment. The emulator is built using the RESTful APIs across the layers which means most of the simulator's components (e.g., cells, UEs, Monitoring Event API, OAuth2 token etc.) are available as APIs, thus it enables third party applications, proprietary equipment, AI/ML services to interact with the components of each layer. On top of that, NEF emulator's compliance with 3GPP makes it interoperable with other solutions. For example, the functionalities of

the management and the exposure layer can be easily integrated with a production-ready 5G Core SBA.



Fig. 44: NEF Emulator's simulated environment

In the exposure layer, the MonitoringEvent API and the AsSessionWithQoS API are the two APIs selected by the SMEs in the EVOLVED-5G ecosystem. They allow network applications to access monitoring information about the UE's lifecycle, and to set up a session with the desired level of quality of service (QoS) for a given IP traffic flow. The MonitoringEvent API supports location reporting and connectivity events, such as the loss of connectivity and reachability events.

### Vertical use cases addressed in 5G PPP

#### Industry 4.0

40. <https://www.innoradar.eu/innovation/47486>

41. <https://www.innoradar.eu/innovation/47484>



## Demonstration of 5G solutions for SMART energy GRIDs of the future

Coordinated by Daniele Porcu (ENEL)

January 2021-December 2023

Website: [www.smart5grid.eu/](http://www.smart5grid.eu/)

Twitter: @smart5grid

### Objectives

Smart5Grid project aims at “5G empowering the energy sector” by providing an innovative and fully featured 5G platform customised for the Energy vertical that allows, not only the smooth integration with the current energy grid communication networks, but, additionally, the experimentation of novel network applications.

### Major results and innovations

- **Open experimental 5G network platform customised for Smart Power Grids** designed to 1) accelerate the development of innovative energy solutions that support the smart management of the energy grid and 2) encourage 3<sup>rd</sup>-party experimentation in 5G and energy fields. The goal is to create an ecosystem that enables the creation, testing, and storage of network applications, facilitating third-party experimenters access to 5G and collaboration, which helps to advance the development and deployment of cutting-edge technologies that will drive the transformation of the energy sector.
- **Open Service Repository (OSR)** for accommodating Network Applications and granting developers, third parties, and SMEs from the energy vertical access to a free execution environment for building and testing their Network Applications.
- **Validation and Verification Framework**, which retrieves the Network Apps from the OSR and runs several checks before the deployment (verification) and with the Network App running (validation). The test results are stored in the platform and are accessible to the user/developer through the OSR. The developers can leverage this open platform to further test and validate their Network Apps, with the objective of delivering better software. The verification part is already complete, and the consortium is currently working on the validation engine.
- **Definition and specification of Smart5Grid Network Applications** as vertical services made of subservices chained together and modelled as either cloud-native VNFs based on OSM Information Model (IM) (aligned with ETSI NFV IM) or pure cloud native technologies like Helm-charts. Network Apps must allow developers to concentrate on building the applications specific to the vertical domain they master but also to leverage the features and performance that 5G networks offer by creating an abstraction of the complexities of the 5G network into a set of requirements, formally captured in what the so-called NetApp descriptor.
- Smart5Grid platform comes along with the required support and assistance through a clear and trustworthy **SME experimentation roadmap**. The consortium partners are currently interacting with external stakeholders through a series of physical workshops in several European countries. The goal is to build awareness about the opportunity offered by the 5G network’s programmability capability for serving different energy use cases, creating interest in becoming part of the Smart5Grid Network Apps ecosystem and experimenting in the project’s open platform.
- **Early versions of the use-case specific Network Apps tested and validated** against the defined functional and connectivity related requirements in **pre-piloting phase**. Two types of pre-piloting architectures were used: energy-service related and 5G connectivity related. The first one involved Real-Time Hardware In the Loop (RT-HIL) technology and a 5G hardware network emulator for realistically emulating the operational conditions of the grid; this setup allowed control-in-the-loop tests for the evaluation of the impact of the communication layer (5G) on the quality of the energy services and their control-related extensions of the Network Apps. The second pre-piloting testbed used actual 5G





infrastructure and grid related sensors; the scope was to ensure that Network Apps can receive/send information to/from the grid sensors, and to test the functional requirements of the services they shall provide.

#### Description of demos, trials and use cases

Smart5Grid is developing high-performance Network Applications that will enable four ambitious energy-oriented 5G demonstrations tailored to the requirements of real operational issues faced by the modern smart energy grids:

- **Automatic Power Distribution Grid Fault Detection:** With the goal to minimize the unavailability of the energy grid during shortages, a strong and reliable communication layer needs to be constantly monitored. **Demonstration setup:** Installation of Remote Terminal Units in a Primary and Secondary Substations of ENEL grid in Olbia (Italy) for transmitting energy telemetry data to the Supervisory Control and Data Acquisition (SCADA) system of the operational centre. Continuous monitoring of communication KPIs not to compromise the effectiveness of the automation system. Public W13 5G network is used.
- **Remote Inspection of Automatically Delimited Working Areas at Distribution Level:** Aiming at enhancing security during maintenance work in a high voltage substation by bordering a safety area in a volumetric way and monitoring workers using a Real Time Location System (RTLS) and Artificial Intelligence (AI). **Demonstration setup:** RTLS, composed of ultra-wide band sensors and cameras, installed at a substation located at Garraf Natural Park (Barcelona, Spain). A private 5G SA network (consisting of vRAN server, Network App server, Core/Platform server and outdoor RRU to provide coverage in the substation) to enable ultra-reliable low latency communication and enhanced mobile broadband has been deployed and tested in laboratory environment. Test showed 13.43 ms a latency average (device to core) achieving throughput and latency targets.

- **Millisecond Level Precise Distribution Generation Control:**

In support to the constantly increasing number of small and geographically spread RES (Renewable Energy Sources), this demo provides RES producers and Grid operators with a low-cost, real-time, and reliable solutions for better visibility, predictability and control of the RES assets enabling eligibility for flexibility exchange participation. **Demonstration setup:** Multiple electrical, technical, and environmental signals and measurements from the SCADA system and IoT sensors of a Wind Farm are communicated by MQTT protocol over a secure private APN in 5G public telco network. The signals are visualised and recorded by a Network App, which allows RES owners and Grid operator to monitor in real time the asset's performance. The signals are recorded on a cloud-based DB to be further analysed and utilised for improved maintenance, acting as enabler for predictive maintenance. The platform is designed for Hydro, Solar and Wind Power Plants.

- **Real-time Wide Area Monitoring:**

Aiming at the creation of an enhanced real time monitoring tool for inspection of power transmission systems spread out across a country wide area. The goal is to augment the power exchanges and system robustness. **Demonstration setup:** Two Phasor Measurement Units (PMU) devices, equipped with 5G gateways, have been deployed in the cross-border area of Northern Greece and Southern Bulgaria. Public 5G networks operated by Vivacom and OTE are used for the collection of PMU measurements in Bulgaria and Greece respectively and their propagation to the edge-cloud server in Bulgaria, hosting a virtual Phasor Data Concentrator (vPDC) and its monitoring and alarming tools.

#### Vertical use cases addressed in 5G PPP

##### Energy



## Vertical Innovations in Transport and Logistics over 5G experimentation facilities

Coordinated by Eleni Giannopoulou (Wings ICT Solutions)

January 2021-December 2023

Website: [www.vital5g.eu](http://www.vital5g.eu)

Twitter: @5gVital

### Objectives

The VITAL-5G aims to revolutionise the Transport and Logistics (T&L) sector by driving and fostering the development and sharing of novel vertical-specific and vertical-agnostic Network Applications for flexible and interoperable deployment through the VITAL-5G platform. The project aims to deliver an open, virtualised 5G-enabled testing and validation experimentation facility, which will provide the means for relevant T&L stakeholders to deploy and benchmark the performance of their innovative Network Applications on top of a 5G network. This experimentation facility will enable dynamic tailor-made service provisioning to 3<sup>rd</sup> parties (such as SMEs) to validate their applications over resources otherwise unavailable to them, thus boosting confidence before actual service deployment. This will lead to enabling novel business models development for open, integrated and cooperative services across multiple domains, addressing specific T&L use cases and justifying the investment from key stakeholders. By fostering the development and advancement of a T&L-centred ecosystem, the project will drive the European integration of 5G services into the T&L vertical and thus, accelerate the adoption and scale-up of the VITAL-5G Facility and Network Applications.

### Architecture

The VITAL-5G architecture, shown in Figure 45, consists of two major layers: the 5G-enabled T&L testbeds distributed in Greece, Belgium and Romania and the cross-facility VITAL-5G open platform for services design, onboarding and deployment, validation and diagnostics applied to T&L vertical services. Any 3<sup>rd</sup> party experimenter (e.g., software developers, networks engineers, researchers) can design their own virtual applications and onboard their packages and images in the VITAL-5G Repository, making them available as software blocks for complex T&L services. The VITAL-5G Portal offers programmable REST APIs (Representational State Transfer

Application Programming Interface) to manage the creation, instantiation, life-cycle management and monitoring of T&L services and related 5G network slices. The Portal interacts with the local Management, Orchestration and slice control systems, the actions of network slice creation, resource instantiation and monitoring data, executed in a unified manner. Moreover, within VITAL-5G we develop a set of Network Applications which aim to showcase T&L use cases, validate the overall functionality of the platform, and simultaneously ease the 3<sup>rd</sup> party service design and experimentation through the re-usage of existing Network Applications as well as the ability for 3<sup>rd</sup> party experimenters to upload and test their own Network Applications. Three industry-driven use cases (UCs) have been selected for trials over the VITAL5G experimentation facilities.

### Description of demos, trials and use cases

- **Use Case 1:** Assisted vessel transport – Antwerp facility: This use case leverages on 5G SA connectivity and network slicing principles to assist vessels in the challenging environment of a port area, i.e., addressing: lack of safety in the port, too large waiting times, and excessive gas consumption. The use case is performed using a real vessel sailing on a normal operational schedule and is outfitted with additional 5G connectivity to support high-bandwidth camera feeds, and real-time sensor data. To tackle the aforementioned challenges, we enable remote vessel monitoring in a busy port area, increasing situational awareness in real-time, and optimising assisted vessel navigation by defining optimal routes and speed leveraging AI/ML methodologies. In particular, a real-time digital twin is developed around the vessel to support the assisted vessel operation. The Antwerp 5G-testbed provides a fully standalone (SA) 5G network supporting 3GPP Rel.16 and comprises a virtualised 5G Core, MEC nodes and multiple end devices, supporting end-to-end slicing.



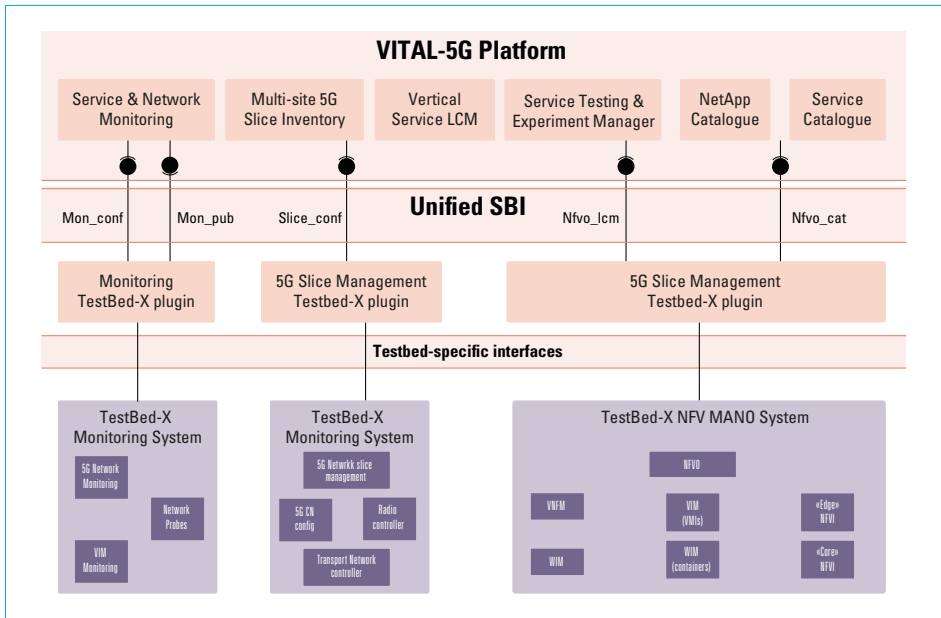

Fig. 45: VITAL-5G platform and test-beds integration

- Use Case 2:** 5G connectivity and data-enabled assisted navigation using IoT sensing and video cameras – Galati Danube River port: This UC is focused on implementing a data-enabled assisted navigation application using IoT sensing system and video cameras installed in the Galati River port, on a ship and barges. The UC will leverage on IoT, data fusion, ingestion, post-processing, fraud detection and sanity checks applied on the sensor data for ship insurance purposes based on AI/ML mechanisms over 5G connectivity. This will allow for safer port operation and more secure navigation, even in severe weather and water conditions. Galati port is an entry point for large shipping traffic from the Black Sea towards continental Europe and is part of the Rhine-Danube Trans-European Transport Network (TEN-T) Corridor. Adverse conditions such as shallow waters, weather conditions and large vessel numbers result in a challenging situation for vessel and port personnel to perform vessel navigation tasks and port operations. The Romanian 5G testbed is based on the Orange Romania (MNO) testbed platform, a Rel.16 SA network, supports various orchestrators (ONAP/OSM), VNF onboarding and network slicing.

- Use Case 3:** Warehouse/freight logistics – Athens facility: This use case explores the potential of using 5G technology to optimize warehouse operations through AGVs, with the goal of eliminating time inefficiencies. 5G connectivity will enable remote surveillance and monitoring of processes, as well as advanced AGV operations including obstacle and human avoidance and collaboration with other automated vehicles. AI and ML techniques are used to optimize the logistics processes with the objective of increasing the warehouse productivity by providing 3 added-value services: a) Autonomous pallet transport within the warehouse, b) Follow-me function for human-robot collaboration and c) remote operation and handling of the AGV. The Athens experimentation facility comprises the 5G-testbed owned by OTE (MNO), created in the context of the 5G-EVE project, and the state-of-the-art logistics hub of DIAKINISIS, the largest 3<sup>rd</sup> Party Logistics Greek operator.



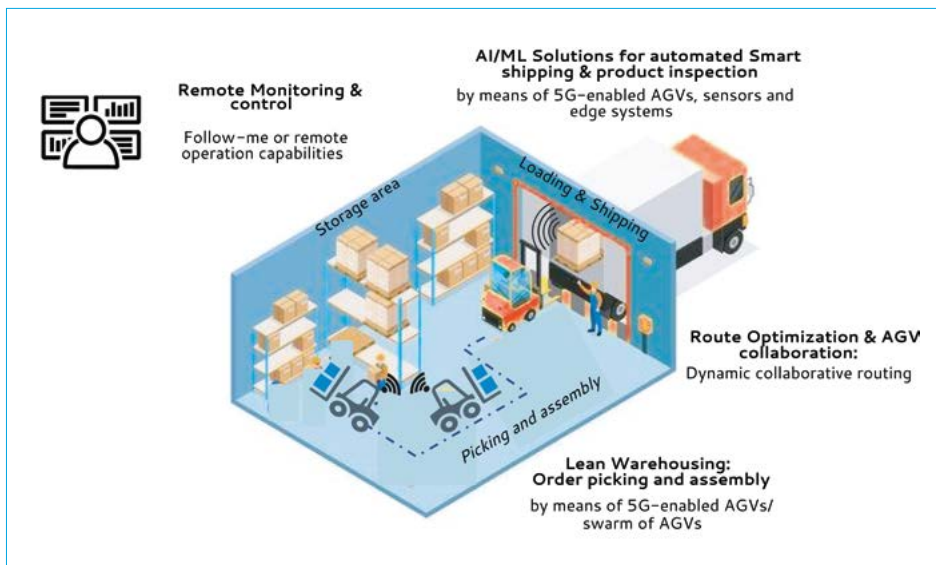

Fig. 46: Warehouse/freight logistics - Athens facility

### Major results and innovations

VITAL-5G impacts the T&L market through the efficient use of 5G networking technologies, thus enabling the realisation of innovative services for T&L end users. The Network Applications that have been developed by the project are expected to accelerate T&L service deployment by abstracting the complexity of 5G infrastructure while ensuring cost-effective use of 5G resources. To facilitate the rapid development of Network Applications and the associated T&L services, the project offers the VITAL-5G Platform, which provides the necessary testing and validation tools, thus enabling both consortium partners and 3<sup>rd</sup> party experimenters with to re-use the existing for developing complex services or develop new ones and deploy Network Applications and vertical services cost-effectively. Furthermore, it offers an Experimentation as a Service (EaaS) facility that experimenters can leverage to rapidly test and validate the deployment of T&L applications under realistic 5G

network conditions. Revenue generation will be through charging customers for platform usage, most likely through subscriptions, support, and consultancy services. In addition, the VITAL-5G Catalogue makes Network Applications available to the platform users, thus encouraging engagement by software developers and other customer types through a revenue-sharing mechanism.

The project has organised demos related to Network Applications' and Vertical Services' onboarding during the two VITAL-5G webinars, the OSM 13<sup>th</sup> *Ecosystem Day and the Transport Research Arena (TRA) 2022* conference. The project has so far published 10 papers, while 4 further papers have been accepted for publication in diverse conferences and journals. Apart from scientific papers, the project is a part of 5 whitepapers under the hospices of 5G PPP.

### Vertical use cases addressed in 5G PPP

#### Transport and logistics

# 5G PPP PHASE 3, PART 6: SMART CONNECTIVITY BEYOND 5G

Ten projects<sup>42</sup> have been retained from the 81 proposals received by the EC in response to

the 5G PPP ICT-52-2020 call: 5G PPP Smart Connectivity beyond 5G.

42. <https://5g-ppp.eu/5g-ppp-phase-3-6-projects/>

## 6G BRAINS

### Bring Reinforcement-learning Into Radio Light Network for Massive Connections

Coordinated by Anastasius Gavras (Eurescom)

January 2021-December 2023

Website: [www.6G-brains.eu](http://www.6G-brains.eu)

Twitter: @6Gbrains

#### Objectives

Ubiquitous smart wireless connectivity is critical for future large-scale industrial tasks, services, assets and devices. Very significantly improved connectivity needs to be unlocked through novel spectrum combinations and the fully autonomous management of the underlying network resources by applying online Artificial Intelligence (AI) at multiple decision layers.

6G BRAINS brings AI-driven multi-agent Deep Reinforcement Learning (DRL) to perform resource allocation over and beyond massive machine-type communications with new spectrum links including THz and optical wireless communications to enhance the performance with regard to capacity, reliability and latency for future industrial networks.

6G BRAINS delivers a novel comprehensive cross-layer DRL driven resource allocation solution to support the massive connections over device-to-device (D2D) assisted highly dynamic cell-free network enabled by Sub-6 GHz, mmWave, THz, Optical Wireless Communication (OWC) and high-resolution 3D Simultaneous Localisation And Mapping (SLAM) of up to 1 mm accuracy. The enabling technologies in 6G BRAINS focus on four major aspects:

- Enhanced new spectrum links: OWC and THz (Terahertz)
- AI-driven D2D cell free network architecture for highly dynamic and ultra-dense connectivity
- AI-based end-to-end directional network slicing with guaranteed QoS over highly dynamic networks
- AI-driven data fusion for 3D indoor position mapping through heterogeneous location methods enabling 1 mm location position accuracy and 1° orientation accuracy.

The proposed solution is being validated by proof-of-concept trials. The primary and secondary applications of THz and OWC technologies for a very broad spectrum of scenarios are evaluated at BOSCH's self-contained smart factory. The developed technologies are widely applicable to various vertical sectors such as Industry 4.0, intelligent transportation, eHealth and others. In particular, new business opportunities emerging in 6G BRAINS have been identified for follow-up exploitation activities. The final results of 6G BRAINS will create a solid basis for future projects and global standardisation for B5G and 6G technologies in areas relevant to industrial environments.



## Major results and innovations

Towards that vision, 6G BRAINS demonstrates how AI-driven multi-agent DRL performs resource allocation over a high dynamic ultra-dense D2D cell free network with new spectrum links including THz and OWC to achieve up to 100 devices per m<sup>3</sup> network density, up to 99.999% reliability and up to 0.1 ms air interface latency for the future industrial network. 6G BRAINS project is the first project to propose a comprehensive cross-layer AI driven resource allocation solution to support the massive connections over D2D assisted high dynamic cell free network enabled by THz/OWC and high-resolution 3D SLAM of up to 1 mm accuracy. In order to achieve this, the enabling technologies in 6G BRAINS have been divided into four major parts including the disruptive new spectrum links, the high dynamic D2D cell free network modelling, the intelligent end-to-end network architecture integrating the multi-agent DRL scheme and AI-enhanced high-resolution radio-light 3D SLAM data fusion.

The major achievements and innovations delivered so far include:

- **Multi-Agent Deep Reinforcement Learning (MA-DRL) scheme specifications and unified software platform.** The MA-DRL scheme specifications provide an extensible foundation to describe the application cases of reinforcement learning within 6G-BRAINS and to develop the framework that will enable implementing reinforcement learning in the 6G network. The MA-DRL scheme operates on the cognitive plane to analyse the system, make decisions and offer intelligent operational strategies such as optimising resource allocation. Different training processes are envisioned such as training decision making policies in a simulated or emulated environment, and deploying them on the 6G network, or training them online on the 6G network. Its implementation relies on a unified software platform to manage both RL training and deployment on 6G systems.
- **3D laser measurement at a factory with 3D cloud scanner and 3D hand scanner, including specifications and upgrade of multiband channel sounder for quad-band measurements at sub-6 GHz + mmWave + THz + OWC in industrial scenarios.** A digital twin of a factory allows better planning of Radio Frequency (RF) and OWC

resources to optimize production processes. A quad-band channel sounder allows simultaneous measurements of bands of interest for the deployment of communication systems in multiple industrial scenarios. The simultaneity accelerates the measurement process and allows direct comparison for analysis. These measurements are combined with the digital twin to offer not only a 3D representation of the environment, but also its RF and OWC twin.

- **Design of an AI based scheduler for Cell-Free (CF) networks with Integrated Access and Backhaul (IAB) and intelligent beam steering.** The scheduling problem in a 5G/6G network is a complex process due to the high dynamic nature of the network and the large number of parameters that influence the performance of the scheduler (which is part of the MAC – Layer 2). To date there is no optimal deterministic model that can be used to resolve this problem. 6G BRAINS developed and simulated a cascaded two step approach (Resource Allocation and Routing) using a distributed supervised learning module to resolve the resource allocation problem and a distributed reinforcement learning approach based on an advanced decentralised routing algorithm called *Relational Actor Critic Router*, which shows in simulations excellent results that are close to optimal.
- **Advanced end-to-end (E2E) network slicing enablers.** This innovation provides E2E software- and/or hardware-based network slicing enablers operating in the radio access, edge, transport and core segments of the E2E 5G/6G infrastructure, leveraging data path programmability, and allowing user-definable flexible classification and prioritisation of traffic in complex networking environments featuring 5G/6G and industrial protocols such as EtherCAT, available in current vertical business use cases, and guaranteeing QoS for the prioritised traffic accordingly.
- **Enablers for 3D localisation.** Infrared (IR), Optical Wireless Communications (OWC), Received Signal Strength (RSS), Sub 6GHz Time of Arrival (ToA), mmWave Angle of Arrival (AoA) & Distance from Orthogonal Time Frequency Space (OFTS) modulation measurement enablers are being developed and captured in a SLAM database, and processed in a SLAM server to obtain position estimates of less than 1 cm accuracy and orientation

estimates in the range of 1° accuracy, which are more accurate and reliable than any one other current location sensing technology.

**Description of demos, trials and use cases**

The *factory of the future* represents one of the most challenging applications of the future mobile communication systems. Many use cases, representative of this application area, have been described in different bodies including 3GPP and 5G-ACIA (see also Figure 47). 6G BRAINS chose use cases which require further improvements compared to current 5G technology. The first use case represents the offloading of the control logic from the industrial controller running as part of a production cell on the shop floor to a dedicated computing area called *factory edge* in a virtualised form as a virtual machine or a container. A more centralised approach, where all controllers (real or virtualised) are placed in the same area, significantly increases the flexibility of the production process, and reduces cost. Connecting the production cells through the 6G BRAINS communication system to the

*factory edge* enables the ease of reconfiguration of hardware and software components on demand. This use case sets very high expectations on the guaranteed latency and deterministic communication that shall support low industrial application cycle times and very precise synchronicity. Another use case is represented by wireless video cameras that are easily deployed in every factory production cell at different locations to send high quality and high frame rate video to an image analysis system located at the *factory edge*. By this, a new level of production monitoring is unleashed enabling a long list of new features such as anomaly detection, improved safety, process tracking and logging, remote control, and predictive maintenance. This use case has high requirements on the data rate consuming up to 3 Gbps per camera in case of state-of-the-art industrial camera systems. Finally, the combination of these two use cases represents a very challenging approach for a system that is required to provide a precise QoS differentiation by, e.g., creating dedicated slices for each service.

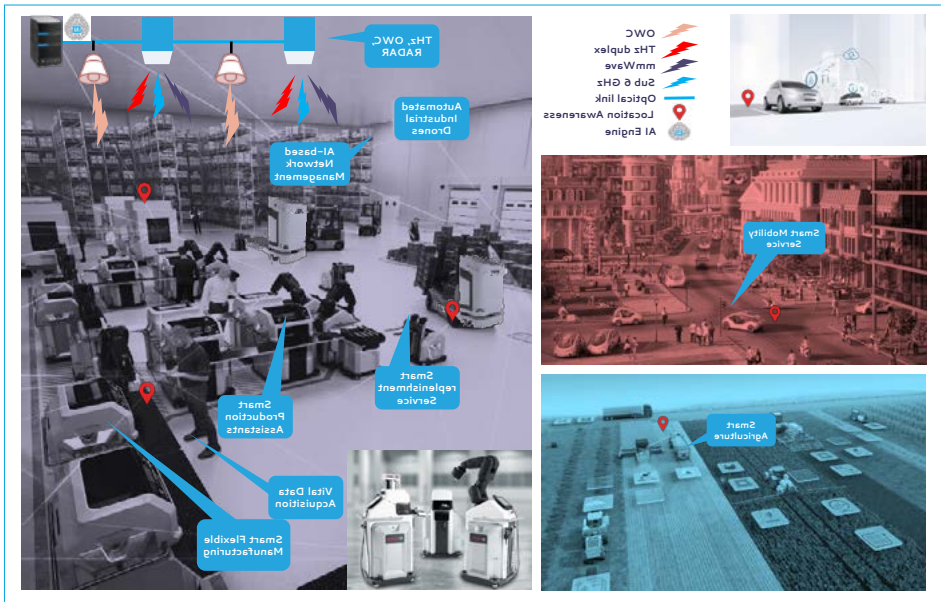

Fig. 47: 6G BRAINS enabled use case (images: Bosch)

**Vertical use cases addressed in 5G PPP**

**Agriculture and agrifood, Automotive, Industry 4.0, Transport and logistics**





## Network intelligence for aDAptive and sElf-Learning MOBILE Networks

Coordinated by Marco Fiore (IMDEA)

January 2021–December 2023

Website: [h2020daemon.eu](http://h2020daemon.eu)

Twitter: [@h2020daemon](https://twitter.com/h2020daemon)

### Objectives

Managing the increased complexity of 6G networks with traditional human-in-the-loop approaches will not be possible anymore. Instead, zero-touch technologies that fully automate the network operation will become the standard, and the success of 6G will vastly depend on the quality of the Network Intelligence (NI) that will run at schedulers, controllers, and orchestrators across network domains, and de-facto manage the infrastructure.

In this context, the DAEMON project aims at ensuring that NI operates optimally in future-generation mobile network infrastructures, by setting forth a more considerate adoption of Artificial Intelligence (AI) models for NI, and a structured integration of NI in 6G systems. To this end, DAEMON will develop and implement updates to the network architecture so that it can best accommodate the NI, as well as re-think the design and integration of machine learning solutions so that they are tailored to network environments, via three objectives.

- **Understanding the limits of AI for mobile networks.** DAEMON will carry out the first systematic, critical analysis of which NI problems can be appropriately solved with AI models rather than other techniques, providing a solid set of guidelines for the utilisation of machine learning in network management tasks.
- **Designing practical NI algorithms empowered by highly customised AI techniques.** For NI problems where AI is an appropriate solution, DAEMON will design tailored AI models that respond to the specific needs of network management functionalities. These models will take advantage of the most recent advances in machine learning to address overlooked design aspects of DNNs that are fundamental for NI, including loss function adaptation, latency guarantees, or reduced requirements in terms of training and computational complexity.

- **Designing an end-to-end NI-native architecture.** DAEMON will define a NI-native network architecture that, stemming from current standardisation trends, enables the coordination of the many and varied NI instances deployed in the network, and goes beyond centralised orchestration to provide NI directly at VNF level.

The advances to NI design and integration devised by DAEMON will be applied to practical network functionalities, demonstrating how NI-driven zero-touch network management can fulfil the performance expectations for 6G in terms of service performance and efficiency, sustainability, and reliability.

### Major results and innovations

The DAEMON project has entered its third year of execution, and attained the following major achievements, in line with the objectives listed above.

- **DAEMON developed a first design for an updated architectural model for mobile networks that are NI-native**, i.e., support NI operations by design. The proposed model stems from an analysis of In current standards and platforms proposed by leading organisations like 3GPP, ETSI or O-RAN, which showed how they have gaps in terms of (i) mechanisms to coordinate intelligence across network micro-domains, (ii) solutions for decentralised and unified data management across NI instances; (iii) support for managing the NI lifecycle; and, (iv) methodologies for the defining and representing of NI models. Our proposed model introduces a novel NI Plane (NIP) that complements those already existing in 5G architectures (i.e., user, control, and management planes) and fills the gaps above.
- **DAEMON developed tens of NI algorithms that support the dependable and automated operation of a target set of 8 key network functionalities**, ranging



from virtualised radio access resource scheduling to automated anomaly response, passing by, e.g., in-band inference and energy-aware VNF orchestration. These NI algorithms build upon and allow to validate guidelines for the design of network-specific machine learning models and consists of tailored deep learning architectures as well as hybrid solutions combining the same with statistical modelling or optimisation tools.

- **DAEMON has produced outstanding scientific and industry impact during the first two years of execution.** On the scientific side, the results produced by the project have been presented at basically all the top-tier conferences in the networking domain, including ACM SIGCOMM, ACM MobiCom, IEEE INFOCOM (where the project contributed 8 papers in three years), ACM CoNEXT, or ACM MobiSys. From the industry side, the project already generated 5 innovative patent applications, all of which have been selected for support by the Innovation Radar initiative of the European Commission. The project also had a significant impact on standardisation, with 39 contributions to SDOs that include O-RAN, ETSI and 3GPP.

### Description of demos and/or trials

The project has developed to date three main demonstrators: (i) a new implementation of an O-DU that takes care of the encoding and decoding capabilities at 5G MAC and PHY levels, so as to integrate NI in vRANs beyond what possible with the current O-RAN standard; (ii) a tool for anomaly detection based on federated learning in mobile edge environment; and (iii) a solution to proactively trigger edge service relocation in order to maintain the level of service quality required by the end user. More demonstrators are planned for the third year of the project: for instance, demonstrators of (iv) the functionalities of the NI Plane, and (v) models for in-band inference at line rate in programmable user planes will be showcased at Mobile World Congress 2023 in Barcelona at the end of February 2023.

Finally, it is worth mentioning that, while the project originally targeted low TRLs for all the technical solutions to be developed, a few of the NI-assisted functionalities already achieved a TRL 5. Indeed, the DAEMON solutions for automated anomaly response for IoT devices and multi-timescale resource management are currently in the process of being validated via pilots in production environments.

## DEDICAT 6G

### DEDICAT 6G – Dynamic coverage Extension and Distributed Intelligence for human Centric Applications with assured security, privacy, and trust: from 5G to 6G

*Coordinated by Vera Stavroulaki (Wings ICT)*

*January 2021-December 2023*

*Website: <https://dedicat6g.eu/>*

*Twitter: @DEDICAT6G*

*LinkedIn: [dedicat6g](https://www.linkedin.com/company/dedicat6g)*

#### Objectives

In future 6G wireless networks, it is imperative to support more dynamic resourcing and connectivity to improve adaptability, performance, and trustworthiness in the presence of emerging human-centric services with heterogeneous computation needs. The aim of DEDICAT 6G is to develop a smart connectivity platform based on the following enablers :

- Enablers for the dynamic distribution of intelligence, the dynamic/aggregate management of communication, computing and storage resources, in conjunction with predictive caching;
- Enablers for the dynamic coverage and connectivity extension through the exploitation of any type of device (e.g., drones, robots, connected cars, other mobile assets like fork-lifts in a warehouse, etc.);



- iii) Security, privacy and trust assurance especially for mobile edge services.
- iv) Enablers for novel interaction between humans and digital systems through innovative

interfaces and devices. The overall goal is to reach higher utilisation of resources; reduction of end-to-end delay and energy consumption; reduction of operational expenditures (OPEX) and capital expenditures (CAPEX).

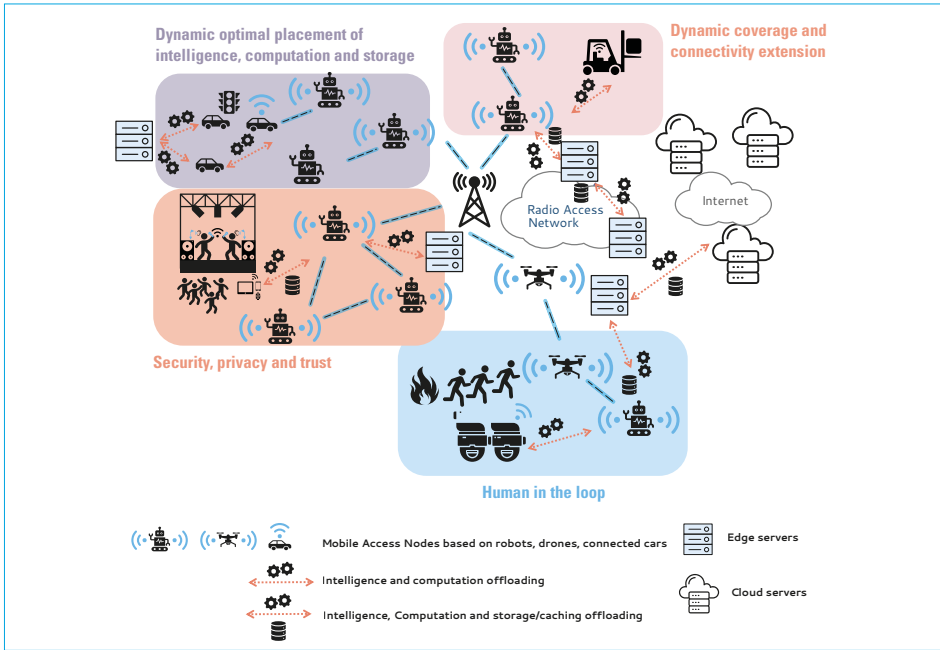

Fig. 48: DEDICAT 6G concept

### Main results and innovations

Figure 48 provides an overview of the project concept. One of the achievements of the specification of the DEDICAT 6G system architecture, including a Functional Model and a Functional Decomposition. While the Functional Model focuses on a layered approach, in organising classes of functionalities with regard to their inherent focuses and roles they partake within the Platform, the Functional Decomposition provides a catalogue of *Functional Components (FCs)* that populated those layers (a.k.a. *Functional Groups (FGs)*). This functional decomposition offers a logical view of which functionalities are needed in the *DEDICAT 6G (D6G)* platform in order to fulfil the project technical objectives (a.k.a. 3 project pillars), namely Dynamic Intelligence Distribution and Coverage Extension, in addition to end-to-end blockchain-based security, privacy and trust.

DEDICAT 6G has also released a first specification and implementation of mechanisms for dynamic intelligence distribution and coverage extension. This includes specification and formulation of algorithms for intelligence distribution and coverage extension, KPIs and target values for mechanisms, based on latest standardisation effort and literature as well as first lab results from testing implemented mechanisms. Moreover, a first approach for the specification and implementation of the DEDICAT 6G security framework and trust management platform has been released. The DEDICAT 6G Artificial Intelligence (AI) powered security management DEDICAT 6G framework aims to offer mechanisms for realising threat detection, classification, and risk mitigation in the context of highly dynamic and distributed communication and computation networks. The project also has also produced an interim version of proof of concepts implementation for the use cases,



which integrate implemented mechanisms for intelligence distribution, coverage extension and security, privacy and trust in the scope of the diverse project use cases. For each use case KPIs based on latest standardisation effort and literature have been specified and first results

on KPIs measurements from testing activities are available.

So far 31 papers from the project have been accepted for publication in diverse conferences and journals. Further information can be found on the project web site.

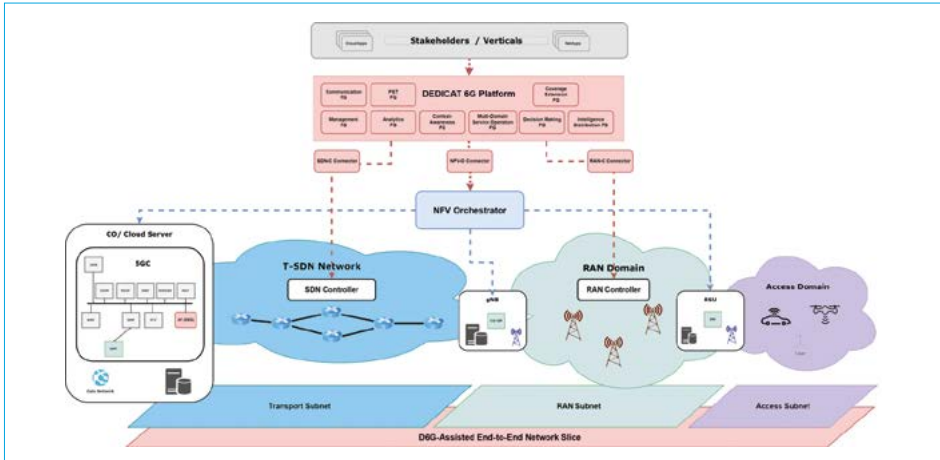

Fig. 49: High level view of DEDICAT 6G architecture



Fig. 50: View of DEDICAT 6G use case pilots testing and validation activities

**Vertical use cases addressed in 5G PPP**

**Automotive, Media and Entertainment, Public safety, Transport and logistics**

## A flagship for 6G vision and intelligent fabric of technology enablers connecting human, physical, and digital worlds.

Coordinated by Mikko Uusitalo (Nokia)

January 2021–June 2023

Website: [hexa-x.eu](https://hexa-x.eu)

Twitter: @Hexa\_X\_2020

### Objectives

The main goal of the Hexa-X project is to define a 6G vision for the world of 2030 which tightly interlinks the human world of our senses, bodies, intelligence and values; the digital world of information, communication and computing; and the physical world of objects, organisms and processes as can be seen in Figure 51. This will be done by addressing the key research challenges: **Connecting intelligence**, both human and artificial; **Network of networks**, integrating resources such as communication, data- and AI- processing, and localisation and sensing optimally connecting at different scales; **Sustainability**, addressing the critical challenges of our modern world both in terms of direct impact, but also leveraging on 6G networks to enable sustainable development both in terms of environmental and societal impact; **Global service coverage**, where digital inclusion will be a top priority and encompass efficient and affordable solutions; **Extreme experiences**, pushing the boundaries of what can be done with mobile wireless connectivity in terms of bit rate, latency, capacity, and localisation and sensing; **Trustworthiness**, ensuring that any 6G network design will be reliable, available, and resilient to be able to handle the critical service expected from the society of 2030.

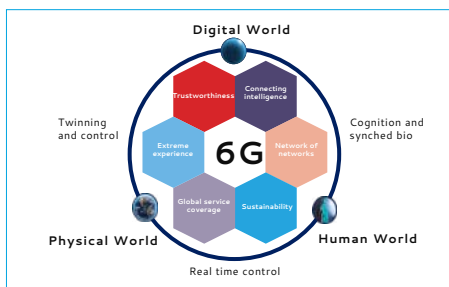

Fig. 51: Hexa-X 6G vision and key research challenges

To address the 6G research challenges, the Hexa-X project designed, developed, and evaluated technological enablers including a) *radio performance* including advances in radio access technologies towards Tbps and high resolution localisation and sensing by exploring GHz and sub-THz frequencies; b) connecting intelligence including native integration of artificial intelligence for e.g. network orchestration and service management as well as dynamic data-driven air-interface design; and c) *network evolution and expansion* to increase the flexibility and efficiency of networks, including specific verticals as well as facilitating the application of intelligent agents in the network by identifying and addressing roadblock in the design.

These technological enablers will be tied together in a framework – the *x-enabler fabric* – which will act as a solution space for the technical work in the Hexa-X project and will be translated into a roadmap for future a 6G end-to-end system that will take into account intangible yet important human and societal needs and values such as sustainability, trustworthiness and inclusion.

### Major results and innovations

#### Hexa-X achievements on the foundations of an end-to-end system towards 6G

Build on x-enabler fabric and 6G vision, Hexa-X developed use cases in various areas<sup>43</sup> and identified their requirements in terms of not only well know KPIs e.g., data rates, capacity, etc. but also in terms of KVis e.g., sustainability, trustworthiness and inclusion<sup>44</sup>. The project has also contributed toward building an E2E system which can satisfy the fine-tuned suitability goals<sup>45</sup> as well as security analysis on the current trends

43. D1.2 [https://hexa-x.eu/wp-content/uploads/2022/04/Hexa-X\\_D1.2\\_Edited.pdf](https://hexa-x.eu/wp-content/uploads/2022/04/Hexa-X_D1.2_Edited.pdf)

44. D1.3 [https://hexa-x.eu/wp-content/uploads/2022/04/Hexa-X\\_D1.3.pdf](https://hexa-x.eu/wp-content/uploads/2022/04/Hexa-X_D1.3.pdf)

45. D1.3 [https://hexa-x.eu/wp-content/uploads/2022/04/Hexa-X\\_D1.3.pdf](https://hexa-x.eu/wp-content/uploads/2022/04/Hexa-X_D1.3.pdf)



and developed new mechanisms for the resiliency of 6G network.

### Hexa-X achievements on radio performance towards 6G

Hexa-X has investigated the sub-THz band (100GHz-300GHz) as an enabler for providing extreme data rate. Radio design aspects including waveform, antenna and beamforming are studied considering the hardware limitations and channel characteristics. It has been shown that transceiver design needs to be tailored to specific scenarios based on communication range and required data rate to improve energy efficiency and reduce costs. Therefore, Hexa-X has explored hardware and channel modelling based on measurement data and used these models in defining several radio options for selected Hexa-X use cases<sup>46</sup>.

To enable services beyond communication, Hexa-X has devised and evaluated several novel methods for localisation and sensing, in terms of the relevant KPIs<sup>47</sup>. These methods aim for extremely high accuracy, low latency, and high resolution, tailored to the Hexa-X use cases. In parallel, Hexa-X has also investigated the use of location and sensing information to improve energy efficiency or achievable rates, based on channel knowledge maps and blockage prediction, respectively. The integration of localisation and sensing into the overall end-to-end architecture, as well as aspects related to spectrum and security have been studied<sup>48</sup>.

### Hexa-X achievements on connecting intelligence towards 6G

Towards having AI-native networks, Hexa-X developed and verified AI-driven air interface methods for a wide range of physical layer functionalities including power amplifier non-linearity compensation, waveform learning, channel decoding, channel estimation, compressed-sensing-based beam selection, and channel charting-based beamforming<sup>49</sup>.

Hexa-X worked towards the vision of 6G network as an efficient AI platform and developed several technical enablers to enable services and data structures for AI applications, performance enhancements of both federated learning and inference type AI applications and multi-agent ML/AI solutions in network applications. Hexa-X developed enablers for AI trustworthiness through addressing security, privacy and explainability aspects of integrating AI-driven methods in the networks<sup>50</sup> (D4.2). Hexa-X investigated the architectural design of the novel management and orchestration (M&O) mechanisms through the adoption of the cloud-native principles adapted to the new generation of 6G telco-grade services. Hexa-X addressed usage of AI/ML techniques applied to M&O, continuum orchestration including different network domains, extreme-edge orchestration, and intent based management (D6.2).

### Hexa-X achievements on network evolution and expansion towards 6G

Towards having intelligent networks, Hexa-X investigated different deployment options for AI functionalities, and developed analytics framework to enable data exposure to AI as a service and explored the concept of programmability. Hexa-X investigated different connectivity options, multi-connectivity, and network of networks and management of the connectivity options to enable flexibly networks by providing communication service when are where it is needed. Towards having efficient networks, function elasticity, RAN cloudification, and efficient signalling have been investigated in Hexa-X<sup>51</sup>.

Hexa-X have worked towards providing extreme experiences in Internet-of-Things and Industry 4.0 environments through developing technical enablers for ultra-flexible resource allocation caused by the bandwidth crunch in traditional radio bands, modelling the 6G dependability in future I4.0 environments, and massive deployment of Digital Twin (DT) in combination with novel human-machine interface (HMI)<sup>52</sup>.

46. D2.2 [https://hexa-x.eu/wp-content/uploads/2022/01/Hexa-X-D2\\_2.pdf](https://hexa-x.eu/wp-content/uploads/2022/01/Hexa-X-D2_2.pdf)

47. D3.1 [https://hexa-x.eu/wp-content/uploads/2022/02/Hexa-X\\_D3.1\\_v1.4.pdf](https://hexa-x.eu/wp-content/uploads/2022/02/Hexa-X_D3.1_v1.4.pdf)

48. D3.2 [https://hexa-x.eu/wp-content/uploads/2022/10/Hexa-X\\_D3.2\\_v1.0.pdf](https://hexa-x.eu/wp-content/uploads/2022/10/Hexa-X_D3.2_v1.0.pdf)

49. D4.2 [https://hexa-x.eu/wp-content/uploads/2022/07/Hexa-X\\_D4.2\\_v1.0.pdf](https://hexa-x.eu/wp-content/uploads/2022/07/Hexa-X_D4.2_v1.0.pdf)

50. D4.2 [https://hexa-x.eu/wp-content/uploads/2022/07/Hexa-X\\_D4.2\\_v1.0.pdf](https://hexa-x.eu/wp-content/uploads/2022/07/Hexa-X_D4.2_v1.0.pdf)

51. D5.2 [https://hexa-x.eu/wp-content/uploads/2022/10/Hexa-X\\_D5.2\\_v1.0.pdf](https://hexa-x.eu/wp-content/uploads/2022/10/Hexa-X_D5.2_v1.0.pdf)

52. D7.2 [https://hexa-x.eu/wp-content/uploads/2022/05/Hexa-X\\_D7.2\\_v1.0.pdf](https://hexa-x.eu/wp-content/uploads/2022/05/Hexa-X_D7.2_v1.0.pdf)



## Description of demos, trials and use cases

Hexa-X developed three demos to demonstrate 6G waveforms in action for communication and beyond communication use cases as described in the following:

In the first demo, multiple modulation schemes have been tested with over-the-air (OTA) link during the project. An example of a single carrier 32-QAM modulation with 8 Gbps signal with EVM of 4.6% at 143 GHz is demonstrated below. The demonstration platform can support proposed 6G waveform candidates. Frequency support can be extended up to 330 GHz with another set of modulated frequency extenders.

In the second demo, analogue multicarrier is illustrated as an implementation of waveforms over an ultra-wideband by splitting the wideband into narrower channels. This allows the use of low-speed and high-resolution analogue-to-digital converters (ADCs) as well as the use of a non-contiguous band. The subchannels are then multiplexed and upconverted to the required radio frequency. The demonstration platform consists of a digital baseband unit,

multiple transceiver chains operating at intermediate frequencies (IF), and a radio frequency radio front end (RFE) transceiver. The platform can be used to demonstrate OFDM waveform variants with real-time processing, and it can be integrated with any RFE that supports 2.4GHz IF input. In the recent experiment, a 26 GHz RFE was used to demonstrate the concept with two channels. The integration with Sub-THz RFE is planned for future experiment.

In the third demo, joint communication and bistatic sensing has been demonstrated and evaluated using signals with 400 MHz bandwidth. The demonstrator is being upgraded to support 800 MHz bandwidth and also a second receiver for multi-static sensing measurements. Work toward demonstration of mmWave/sub-THz positioning with cm-level precision is also ongoing.

## Vertical use cases addressed in 5G PPP

**Agriculture and agrifood, Automotive, eHealth and wellness, Industry 4.0, Media and Entertainment, Public safety, Smart cities and utilities, Transport and logistics**

# MARSAL

## Machine learning-based, networking and computing infrastructure resource management of 5G and beyond intelligent networks

*Coordinated by John Vardakas*

*January 2021-December 2023*

*Twitter: @MarsalProject*

*Website: marsalproject.eu*

### MARSAL concept

MARSAL proposes a novel converged optical-wireless configuration based on the Cell-Free (CF) concept that targets flexible connectivity of a massive number of Radio Units (RUs) and aims to unlock the potential of user-centric CF deployments in 6G networks, while aligned with

the O-RAN initiative. The proposed approach is illustrated in Figure 52 and consists of an evolved 3GPP NG-RAN that is extended with emerging CF technologies, and of an innovative optical transport domain that deploys a distributed edge infrastructure with Data Centres (DCs) structured in 2 tiers, featuring Regional Edge and Radio Edge nodes.



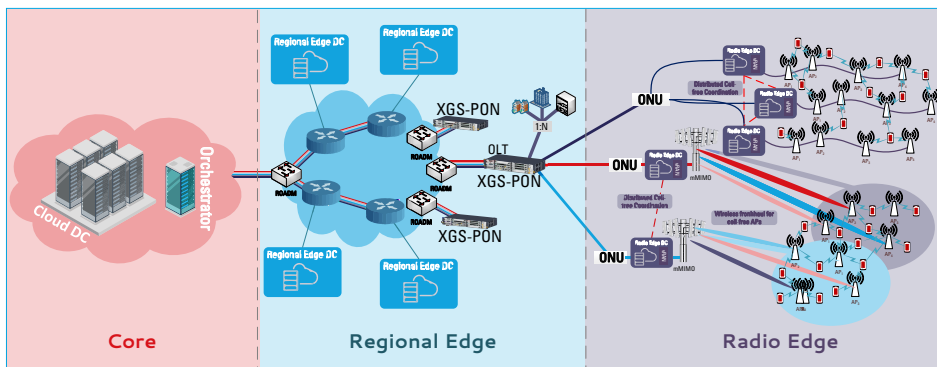

Fig. 52: MARSAL architecture

### MARSAL Network Architecture

At the radio edge, the proposed radio network configuration is based on two radio access solutions. The first solution is based on the interconnection of multiple RUs with the DU (Distributed Unit) via a bus configuration (upper right part of Figure 52.). This approach aims at addressing the most pressing CF limitations, as well as dealing with the fact that the clustering literature only considers disjoint RU clusters, even when multiple Central Processing Unit (CPU) nodes are assumed. Under this networking configuration, clusters of RUs, connected to multiple DUs, jointly address inter-DU and RU-DU coordination for the first time, while also considering the introduced by fronthaul and midhaul constraints. The second solution for MARSAL's radio edge is based on an mmWave Hybrid Fronthaul for CF networks that targets to provide support to CF networks through advanced beamforming solutions. In this way, various RU topologies can be supported, where RUs can be reassigned to different DUs on demand. For the provision of this point-to-multipoint connectivity, MARSAL targets a new design of a mmWave radio node, by utilising RFIC (Radio Frequency Integrated Circuit) mmWave beamforming transceiver and phased-array antenna module provided by MARSAL's partner PT. In this way, diverse innovations can be provided by the MARSAL partners, related to optimal RU deployment strategies, new formulations of dynamic RU clustering and adaptive coordination problems, and studying the effect of functional splitting in the context of the CF fronthauling compatible with 3GPP's Options 1-8.

The MARSAL network architecture is also aligned with the O-RAN alliance. MARSAL extends the O-RAN disaggregation of the BBU (BaseBand Unit) in an O-DU with the real-time functions, and an O-CU with the non-real time functions. Specifically, the latter is further disaggregated into the Central Unit Control Plane or CU-UP (O-CU-UP) and the CU-CP (O-CU-CP). To deploy the CF vRAN solution on the radio edge DC, we can consider higher and lower layer split suggested by 3GPP, ORAN, and small cell forum. MARSAL's approach also defines an Open Fronthaul interface supporting an option O-RAN 7.2x split, and new mid-haul interfaces that interconnect the O-CU-UP and O-CU-CP elements (termed E1), the O-CU and O-DU elements (termed F1) and the Near Real-Time RAN Intelligent Controller or Near-RT RIC and CU (termed E2). The MAC (Media Access Control) scheduler is able to incorporate the large-scale coefficient (path loss and shadowing between the corresponding UE and RU) and the small-scale fading coefficient (indoor NLOS, indoor LOS, etc.) in order to implement the centralised precoding decisions at the non-Real-Time RAN Intelligent Controller (nRT-RIC).

In parallel, MARSAL's converged optical-wireless network considers an optical transport network, which interconnects regional edge nodes through a ring configuration. MARSAL incorporates XGS-PON for PtMP communications, offering connection to multiple DUs. Both fixed and mobile users share the same mid-haul and edge infrastructure (e.g., MEC hosts) and are both served by the same core network. At the regional node, two SDN controllers are considered, for managing the optical and wireless





networking resources, respectively. The controllers at the edge are coordinated by the Network-Slicing-as-a-Service (NSaaS) subsystem at the core-tier Network Function Virtualisation Orchestrator (NFVO), communicating via the OR-Wi interfaces.

A significant part of MARSAL's network configuration is the intelligent network management and orchestration system, which is based on a converged SDN control plane. This innovation considers a hierarchical design by including controllers in multi network tiers, thus ensuring scalability, flexible traffic control, and dynamic configuration of the optical components. This solution allows the intelligent management of storage, computation, and networking resources under a unified infrastructure. The design of MARSAL's Elastic Edge Cloud Infrastructure is an ETSI compliant MEC platform that is able to support coordinated resource allocation for MEC applications and 5G/6G Network functions. MARSAL also aims at extending the Mobile Edge (ME) platform at the host level, to allow MEC applications to be accessed by any user-equipment, irrespective of physical location. At the core, the orchestrator is integrated to the NFV infrastructure and supports coordinated resource allocation for MEC applications and network functions by coordinating two diverse management and orchestration subsystems (i.e., the NFVO and the MEC Application Orchestrator (MEAO)). MARSAL goes a step further on MEC orchestration by disaggregating the functionality of the MEAO, which is the transformation of MEO in the ETSI MEC/NFV architecture, into multiple local replicas. Moreover, MARSAL aims at achieving self-driven and closed-loop autonomy for the Virtual Elastic Infrastructure in order to enable dynamic orchestration and management of networking and computing resources. To this end, MARSAL incorporates a distributed approach that involves Analytic Engines at all tiers of the Edge infrastructure, and Decision Engines in the two Core-Tier orchestration subsystems, targeting to overcome the isolation and underutilisation of resources deployed at Edge nodes, through resource sharing.

For the network security pillar of MARSAL, three main contributions are considered in the overall

architecture. Firstly, the solution for private and secure exchange of data among tenants through decentralised framework for confidentiality and trust that is based on novel data privacy representation techniques that are integrated into a smart contract platform. Secondly, the solution for ensuring data security through different policies and distributed storage of the data. Finally, the solution for network security protection through two different technologies that allow the analysis of the data transferred by the network in real time. Thus, MARSAL do not limit itself to the typical network security (also covered using accelerated hardware ML), but it also aims at protecting the data stored in the cloud, allowing secure multi party computation and distributed data storage, while also it allows the cooperation among tenants by allowing them to automatically sign smart contracts and share data in a privacy preserving way.

The definition of the MARSAL architecture has been finalised, as well as the development of the algorithms for the radio-edge part of the architecture, i.e., the distributed processing and approaches for disaggregation of the RAN functionalities, the clustering and selecting groups of O-RU to serve users, and the joint resource allocation (clustering) and precoding optimisation, as well as for the MARSAL O-RAN E2 Interface Enhancements. Furthermore, the architecture of the network management infrastructure has been finalised, as well as the development of traffic management and network slicing reconfiguration algorithms and for the solution of the Virtual Network Embedding (VNE) problem. Finally, the design of the decentralised framework for confidentiality and hardware-accelerated security mechanisms, and the MARSAL smart-contracting approach have been finalised, while a solution for supporting different infrastructure owners that considers access restrictions that must be considered when accessing and processing their data is also developed.

#### Vertical use cases addressed in 5G PPP

**Automotive, eHealth and wellness, Energy, Industry 4.0, Media and Entertainment, Public safety**



## Resilient interactive applications through hyper diversity in energy efficient RadioWeaves The next generation of multi-antenna connectivity

Coordinated by Marion Habernig (Technikon)

January 2021-June 2024

Website: <http://reindeer-project.eu>

Twitter: @H2020Reindeer

### Objectives

The REINDEER project develops a new wireless infrastructure, 'RadioWeaves', consisting of a fabric of dispersed electronic circuits and electromagnetic surfaces that collectively function as a massive, distributed resource offering hyper-diverse connectivity, positioning, wireless power transfer and computational capabilities. This architecture brings the capabilities of multi-antenna systems to a next level upon the foundations of cell-free massive MIMO systems and is based on large intelligent surfaces, which can be integrated into walls and furniture present in the different deployment scenarios meeting the challenges of new interactive, real-time and real-space applications. The project focuses on five specific objectives to advance the technical visions:

- Analysis and specification of technical requirements for future interactive applications in industrial, care, and entertainment use cases.
- Development of the transformational RadioWeaves smart connectivity platform as energy-efficient, smart, scalable and secure connectivity infrastructure and topologies for zero-outage and efficient and secure deployment.
- Development of scalable protocols and algorithms for cell-free operation and signal processing solutions for resilient interactive applications and cooperation with 'energy-neutral' devices through pro-active diversity, location learning, and distributed intelligence.
- Experimental validation and demonstration of the RadioWeaves smart connectivity platform and the REINDEER algorithms for robust applications and interaction with energy-neutral devices.
- Sharing the REINDEER results with a broad group of stakeholders and the scientific community, promote technological vision in

pre-standardisation activities, and ensure interoperability.

### Major results and innovations

The REINDEER project brings essential innovation to progress both the platform architectures and the protocols and algorithms to realize the great potential in actual deployments and to establish future interactive applications. The following main achievements have been reached so far:

- **Performance Evaluation:** REINDEER has analysed interactive use cases in four focus application domains (adaptive robotised factories, warehouses, retail and logistics, immersive entertainment for crowds of people, Human-machine interaction in care environments, hospitals and assisted living, and smart homes). Quantitative technical requirements were derived, a variety of KPI's formulated including communication and localisation parameters<sup>53</sup>
- **Radio Access Network:** REINDEER develops RadioWeaves technology, providing a new smart connect-compute platform consisting of interconnected distributed resources to provide uniform good service levels. Architectures are designed to support communication, localisation, and wireless power transfer to interact with energy-neutral devices. A new terminology and federation-based approach is proposed to allocate infrastructure resources to services. Channel characterisation for these new radio networks has been performed based on measurement campaigns<sup>54,55,56</sup>

53. <https://reindeer-project.eu/public-deliverables/>

54. <https://5g-ppp.eu/reindeer/>

55. <https://reindeer-project.eu/public-deliverables/>

56. G. Callebaut, W. Tärneberg, L. Van der Perre, E. Fitzgerald, 'Dynamic Federations for 6G Cell-Free Networking: Concepts and Terminology', 2022 IEEE 23rd Intl. Workshop on Signal Processing Advances in Wireless Communication (SPAWC), <https://arxiv.org/abs/2204.02102>

- **Integrated communication sensing and localisation:** REINDEER has developed algorithms and architectures for supporting interactive applications perceived as 'real-time' and 'real-space', i.e., where the physical and virtual worlds share the same reference frame. These tackle the performance/complexity/interconnect challenges in distributed deployment and cell-free operation. Protocols for initial access, synchronisation, and calibration in new distributed networks, are designed<sup>57,58</sup>.
- On top of communication, RW will feature a new range of intelligent services through capabilities that are inherent to its architecture. Deploying large and distributed electromagnetic surfaces will lead to unforeseen spatial resolutions that will enable precise localisation even with a limited bandwidth. In contrary to conventional beamforming, the emitted radio signals will be largely uncorrelated everywhere, except at desired focal points. This paves the way for wireless power transfer at unprecedented power levels, while keeping the overall electromagnetic exposure low in the vicinity. Both localisation and wireless power transfer, offered as services from the infrastructure, will ultimately open the doors for novel location-aware applications and the operation of new generation of highly capable energy-neutral devices.

### Description of demos, trials and use cases

Future applications in the field of industry, healthcare and entertainment will depend on wireless connectivity to provide resilient interactive experiences with uninterrupted availability both in time and location, with unnoticeable dislocation between virtual and real elements. Therefore, we focus on four main application domains, where RadioWeaves becomes more relevant to drive REINDEER innovations:

- **(A) Adaptive robotised factories, warehouses, retail and logistics:** In future factories, warehouses, and logistics, applications will critically rely on wireless connectivity, requiring zero-outage and imperceptible latency communication. Manufacturing and industrial settings are typically highly reflective and feature many blocking objects. Future interactive applications in these environments will hence face a combination of challenging requirements. Defined use cases are:
  - Real-time digital twins in manufacturing;
  - Human and robot co-working;
  - Tracking of goods and real-time inventory;
  - Electronic labelling;
  - Augmented reality for professional applications;
  - Position tracking of robots and UVs (Unmanned Vehicles)
- **(B) Immersive entertainment for crowds of people:** The future connectivity infrastructure needs to offer a capacity that can be scaled up to support a very high number of individual video services and with enhanced user experiences, to be offered in places where crowds gather, far beyond the capabilities current and emerging wireless networks. This occurs in large and, typically, relatively open spaces such as stadiums, festival grounds, or large halls and auditoriums. Defined use cases are:
  - Augmented reality for sport events
  - Contact tracing and people tracking in large venues
  - Location-based information transfer
- **(C) Human-machine interaction in care environments, hospitals and assisted living:** Future human-oriented applications will need to provide intuitive experiences for people interacting with robots and objects in their environment. The people-friendliness of the experiences is therefore extremely important, including both the reliability of the application and the aesthetic of the integration of the infrastructure in the environment. Defined use cases are:
  - Patient monitoring with in-body and wearable sensors
  - Human and robot co-working
  - Augmented reality for professional applications
  - Wander detection and patient finding
  - Contact tracing and people tracking in large venues
  - Location-based information transfer
  - Virtual reality home gaming
  - Smart home automation

57. <https://reindeer-project.eu/public-deliverables/>

58. <https://reindeer-project.eu/scientific-publications/>

· **(D) Home automation and smart home systems:** Our homes are becoming increasingly connected and automated and we foresee this trend reaching a new level of sophistication with the help of energy-neutral devices, which allow for extremely dense deployments of sensors and actuators with no maintenance. Entertainment options at home are also expanding with the advent of virtual reality. In this domain, we need to meet performance

requirements while keeping costs low so that products are accessible to consumers. Defined use cases are:

- Virtual reality home gaming
- Smart home automation

#### Vertical use cases addressed in 5G PPP

**Energy, Industry 4.0, Media and Entertainment, Transport and logistics**

## RISE-6G

### Reconfigurable Intelligent Sustainable Environments for 6G Wireless Networks

Coordinated by Emilio Calvanese Strinati (CEA-Leti)

January 2021-December 2023

Website: [rise-6g.eu](http://rise-6g.eu)

Twitter: @rise-6g

LinkedIn: RISE-6G

#### Objectives

RISE-6G is bringing a radical paradigm change to current generation wireless networks by introducing innovative components based on Reconfigurable Intelligent Surfaces (RISs) to forge a new generation of dynamically programmable wireless propagation environments. Those are poised to support dynamic adaptation to future stringent and highly varying B5G/6G service requirements in terms of Electromagnetic Field (EMF) emissions, localisation accuracy, Energy Efficiency (EE), secrecy guarantees, as well as legislation and regulation changes, while incurring minimal connect-compute network redesign and reconfiguration costs, thus enabling the concept of “*wireless environment as a service*”.

The project aims to identify, define, and analyse new scenarios where the RIS technologies offer capabilities for improving system performance, layout flexible RISE network architectures, and define new network-centric performance KPIs for RISE connectivity.

The goal is to enhance RISE networking wireless communications in terms of reliable coverage (10x), data rates, reliability, and massive connectivity – simultaneously empowering and taking advantage of cutting-edge technologies of Mobile Edge Computing (MEC) and Artificial

Intelligence (AI). RISE networks are designed to enable boosted cm-level/degree-level environmental awareness, including joint mobile position/attitude estimation, mapping, and sensing/detection functionalities.

To those ends, RISE-6G’s activities are additionally focused on the design, prototyping, characterisation, measurement, integration, and validation of RIS while modelling the electromagnetic behaviour through a comprehensive sounding and simulation campaign. The outcomes are set to culminate in the realisation of two field trials in Rennes SNCF train station and a CRF smart factory – showcasing the enhanced communication capability and localisation that is enabled by the RISE-6G concept and technologies to meet the most demanding B5G/6G KPIs.

#### Major results and innovations

**Dissemination output** – As of the end of the second year of its lifetime, RISE-6G has submitted 20 deliverable reports, had more than 30 inputs across different bastardisation fora, resulted in over 100 peer-reviewed publications – with many more under submission, and maintained a strong community presence via various communication activities, including talks, presentations, tutorials, special sessions, and a proof-of-concept demonstration.

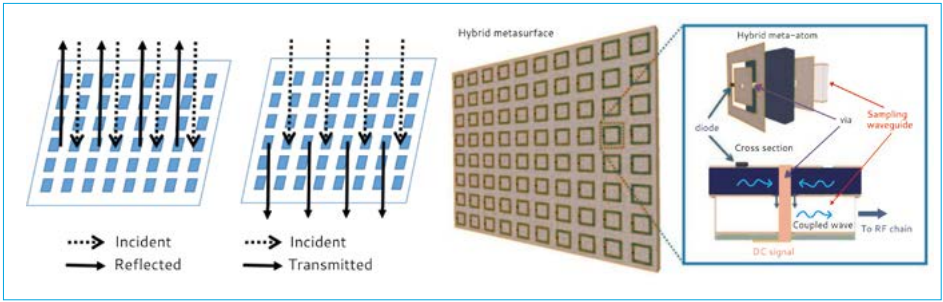

Fig. 53: Design and operations of Reconfigurable Intelligent Surfaces (RISs) for intelligent control of the wireless propagation medium

**All-in-one architecture** – The project is forging and elaborating the necessary system-level vision needed to unleash the high potential of RISs in B5G/6G systems, developing suitable wireless network architectures, over-the-air communication and localisation protocols, control strategies for RISE networks, and related signal-processing, machine learning, and AI frameworks and algorithms.

**Evolutionary hardware development and experimental prototyping** – The technology challenge of RIS hardware design is being addressed by demonstrating their cost-effective realisation at a wide range of operating frequencies. Apart from the modelling and characterisation results, multiple prototypes have been developed, and the ongoing measuring campaign is designed to provide ground-truth data that are currently being used for the planning of the final field trial demonstrations.

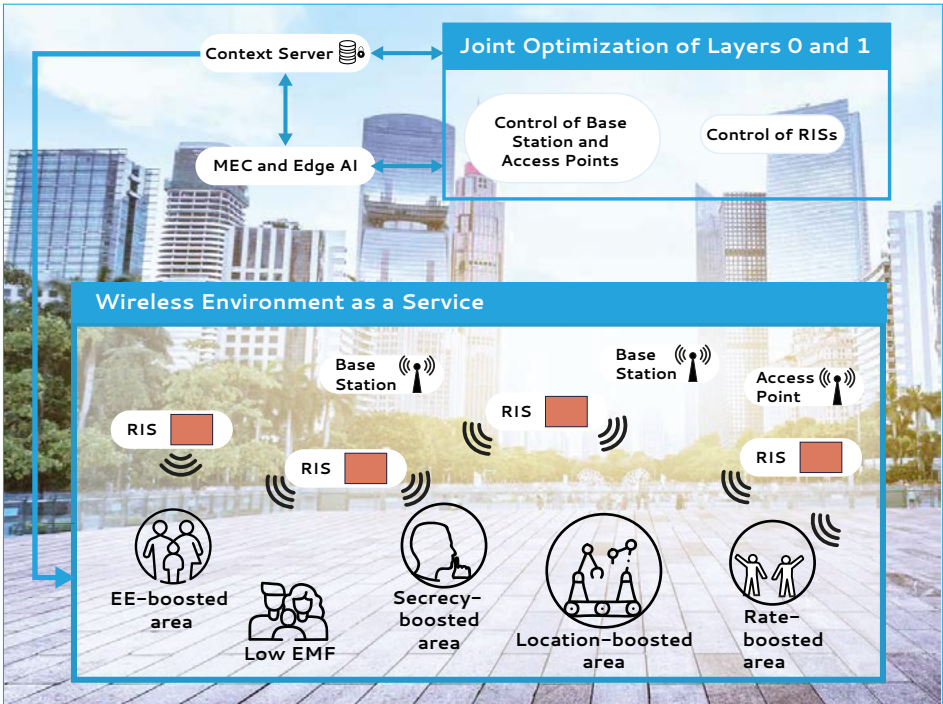

Fig. 54: The concept of wireless environment as a service brought by jointly optimising the lower network levels for achieving different performance objectives within the same environment.

**Intelligent control mechanisms** – The joint orchestration and control of RIS components with the conventional wireless transceivers' settings is a primary focus of investigation. Intelligent mechanisms are being developed and proposed that iteratively monitor relevant environment metrics, self-adapt RIS configurations, and refine network communication parameters (e.g., emitted power or wireless channel estimation) to achieve high KPI performance in terms of enhanced QoS, localisation accuracy, EE, low EMF, and increased secrecy in dedicated

boosted service areas. Advancements in this area include newly defined protocols, channel estimation techniques, comprehensive and low requirements system integration, as well as novel optimisation algorithms.

#### Vertical use cases addressed in 5G PPP

**Automotive, Energy, Industry 4.0, Media and Entertainment, Public safety, Smart cities and utilities, Smart airports/ports, Transport and logistics**

## TeraFlow

### Secured Autonomic Traffic Management for a Tera of SDN flows

*Coordinated by Ricard Vilalta (CTTC)*

*January 2021-June 2023*

*Website: [teraflow-h2020.eu](http://teraflow-h2020.eu)*

*Twitter: [@TeraFlow\\_h2020](https://twitter.com/TeraFlow_h2020)*

#### Objectives

TeraFlow is delivering a new generation open-source cloud-native SDN controller to provide secured and smart connectivity services to B5G/6G networks. This new SDN controller has been established as an OSG at ETSI as TeraFlowSDN (TFS). TeraFlowSDN controller is able to integrate with current NFV and MEC frameworks as well as to provide revolutionary features for flow aggregation, management (service layer), network equipment integration (infrastructure layer), and AI/ML-based security and forensic evidence for multi-tenancy. The project proposes an integrated solution for tackling various challenges of B5G networks to support service providers and telecommunication operators in their journey towards future networks.

The source code of the second release of the TeraFlowSDN Controller is publicly available for download and installation at the ETSI GitLab repository under Apache2 license.

#### Major results and innovations

TeraFlowSDN is a cloud-native SDN (Software-Defined Networking) controller composed of multiple container-based services using novel virtualisation techniques, which are deployed as micro-services and managed on elastic infrastructure through agile DevOps processes and continuous delivery workflows.

These micro-services are structuring an application as a collection of interconnected and related services using a common integration fabric. In a micro-services architecture, services are simple and detailed, and the protocols are lightweight.

Release 2 provides extended support for OpenConfig-based routers and a new type of interaction with optical SDN controllers through the ONF Transport API. Moreover, release 2 includes complete integration for microwave network elements (through the IETF network topology YANG model), and Point-to-Multipoint integration of XR optical transceivers and P4 routers. New capabilities for P4 routers include the ability to load a P4 pipeline on a given P4 switch; to obtain runtime information (i.e., flow tables) from the switch; and to push runtime entries into the switch pipeline.

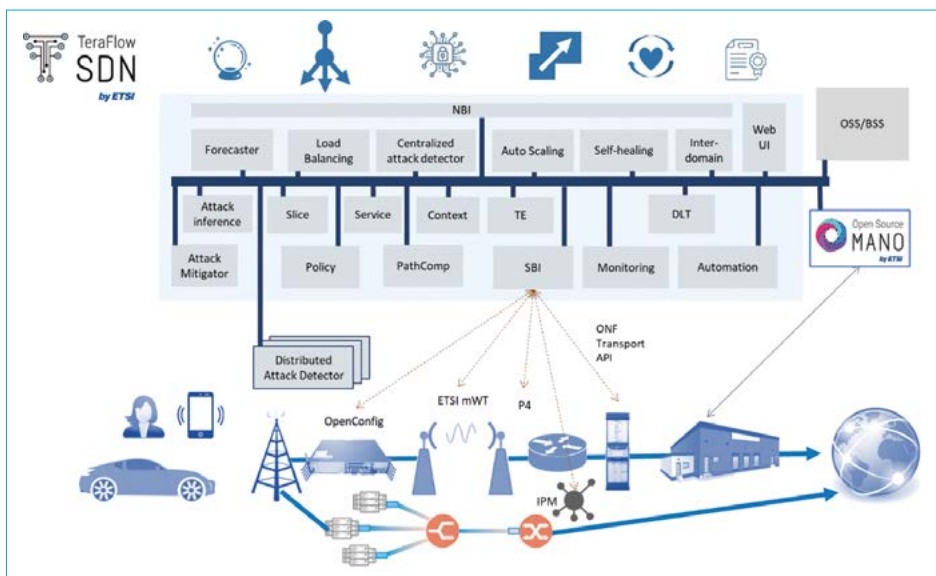

Fig. 55: TeraFlowSDN controller cloud-native architecture

SLA validation has been re-engineered through all the workflows, from device monitoring, up to service and slice life cycle management. Thus, the Slice, Service, Policy, Device and Monitoring Components have been updated to support the necessary network automation workflows. Moreover, Release 2 brings a new component called Path Computation, enabling new use cases, such as energy-aware service placement.

Cyber-security mechanisms have been improved, including new components for distributed or centralised attack detection, inference, and mitigation, enabling also novel use cases. DLT has been extended to interact with the Inter-domain Component and make use of a deployed Hyperledger Fabric.

### Description of demos, trials and use cases

#### Autonomous Network Beyond 5G

A set of multiple integrated network elements are considered in network technological domains and used to support the autonomous provisioning and subsequent configuration and management of a transport network slices, consisting of multiple VPN services such as Layer 2 (L2VPN) and/or Layer 3 (L3VPN) services with dedicated SLA. Another possibility is the interaction of an NFV Orchestrator (e.g., ETSI OpenSource

MANO) with TeraFlowSDN North-Bound Interfaces (NBI), which include provisioning of L2/L3VPN connectivity. In all these service requests, the TeraFlowSDN controller is able to trigger the necessary handlers to interact with the underlying technological domains.

#### Inter-domain

Transport and cloud infrastructures are administratively partitioned into different domains, each controlled by a TeraFlowSDN Controller instance. In addition to selected uplink-heavy and latency-sensitive scenarios, the intention is to focus on OTA software updates, which are software improvements that a car company sends wirelessly to vehicles. This OTA updates need to reach a moving target; thus, we provide an inter-domain scenario for moving connectivity services based on the position of the network elements. Testing and experimentation will be necessary to address the role of the Transport Network Slice and its endpoints regarding the interaction with adjacent access and service edge (SDN) control domains in this inter-domain scenario.

#### Cyber-security

Nowadays, when an operator moves towards an automated environment, security becomes a key feature since network operations are done

by software components operating without human intervention or oversight. Thus, security must undergo a similar technological evolution to enable the resilience of SDN controllers, the automation of security policies over the network, the use of to detect and identify attacks, the

utilisation of DLT to assure configuration and forensic capacity, and the deployment of NFV security functions.

### Vertical use cases addressed in 5G PPP

#### Automotive

## B5G-OPEN

### OPTical nEtwork continuum

*Coordinated by Dr Oscar Gonzalez de Dios (Telefonica)*

*November 2021-October 2024*

*Website: [b5g-open.eu](http://b5g-open.eu)*

*Twitter: [@B5gOpen](https://twitter.com/B5gOpen)*

#### Vision and objectives

B5G-OPEN targets the design, prototyping and demonstration of a novel end-to-end integrated packet-optical transport architecture based on Multiband (MB) optical transmission and switching networks. MB expands the available capacity of optical fibres, by enabling transmission within S, E, and O bands, in addition to commercial C and/or C+L bands, which translates into a potential 10x capacity increase and low-latency for services beyond 5G with respect to widely deployed C-band systems. To realize multiband networks, technology advances are required, both in data, control and management planes. Concerning devices, these include new amplifiers, filterless subsystems, add/drop multiplexers, etc. Such technology advances complement novel packet-optical white boxes using flexible coherent sliceable Bandwidth Variable Transceivers and novel pluggable optics. The availability of MB transmission will also lead to a complete redesign of the end-to-end architecture, removing boundaries between network domains and reducing electronic intermediate terminations. The control plane will be extended to support multiband elements and a 'domain-less' network architecture. It will rely on physical layer abstraction, new impairment modelling, and pervasive telemetry data collection to feed

AI/ML algorithms that will lead to a Zero-Touch networking (ZTN) paradigm including a full featured node operating system for packet-optical white boxes.

The results will be shown in two final demonstrations exposing the project benefits from operator and user perspectives.

To meet the above vision, the project has established ambitious but realistic and achievable objectives as detailed below:

- Design a cost-effective, energy-efficient, programmable, and disaggregated end-to-end optical network, which removes terminations between network domains, thus drastically reducing electronic hops, to provide an optical network continuum between access, metro, and core segments.
- Design and validation of an innovative optical transport infrastructure supporting MB connectivity and transparent network continuum from User Equipment to DC.
- Design of novel optical network devices for switching, amplification and transmission to enable B5G-OPEN solutions and demonstration.



- Design and validation of next-generation optical access & X-haul for B5G applications enabling massive cost-efficient 5G and Li-Fi small cell deployment.
- Development of an end-to-end monitoring platform covering the optical MB transmission, switching and the packet layer.
- Design, implementation and validation of an operating system for the novel network elements.
- Design, implementation and validation of the service orchestration and infrastructure control system.
- Build a framework for an AI-assisted autonomous and dynamic network supporting real time operations and ZTN.
- Influence major vendors and service providers to adopt B5G-OPEN principles.

### Architectural Approach

B5G-OPEN is **proposing a novel architecture** that is agnostic with respect to actual architectures and technologies used for its implementation (optical, packet and IT-data centre).

The proposed architecture (designed and successfully completed during its first year of implementation of the project) not only responds to needs identified in the form of several use cases for using B5G-OPEN technologies but also prepares the network for supporting them (possibly, all of them) by providing them with the necessary network capacity, latency, and availability requirements:

- Holographic-Type Communications (HTC)
- Tactile Internet and Remote Operations (TIRO)
- Intelligent Operation Network (ION)
- Network and Computing Convergence (NCC)
- Digital Twins (DT)
- Industrial IoT with Cloudification (IIOT)

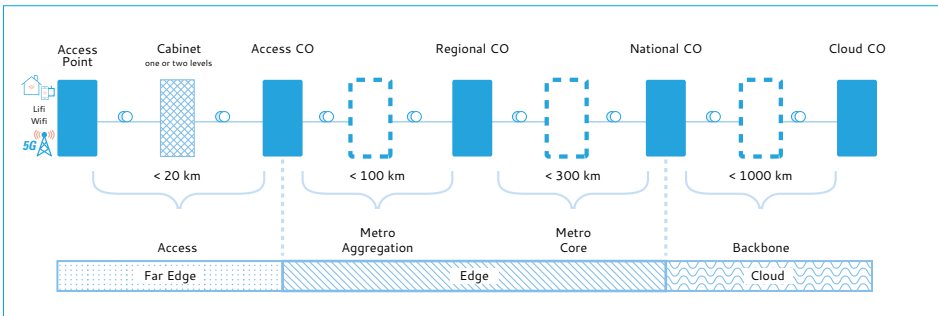

Fig. 56: B5G architecture

### Ongoing work, major results and innovations

Design and validation of:

- A MultiBand (MB) optical transport and X-haul network infrastructure, based on specifically designed MB node architectures, MB switching, MB amplification, and MB transmission solutions, cost-effectively addressing the 10x bandwidth increase, providing open and fast programmability, and enabling an end-to-end continuum that drastically reduces electronic regeneration across network segments.
- A telemetry-based zero-touch control plane, able to orchestrate services across the

end-to-end underlying infrastructure, jointly optimising the packet and MultiBand optical layers, while ensuring scalability and reliability, supporting intent-based autonomous networking and Machine Learning (ML)-driven network operation for network infrastructure self-diagnosis.

Thirteen B5G-OPEN works will be presented at the next Optical Fibre Communication (OFC) Conference. They include innovative solutions at both data and control plane levels, such as intelligent optical telemetry architectures and solutions for packet-optical networking and optical digital twin, multiband transmission





and programmability, studies on the impact of fault-induced power transients, optimal design of filter-less horseshoe networks supporting point-to-multipoint transceivers.

#### Vertical use cases addressed in 5G PPP

Industry 4.0, Media and Entertainment, Smart cities and utilities



# 5G PPP PHASE 3 SUPPORT: 6GSTART CSA PROJECT

---

The European 5G Annual Journal was prepared by the 6GStart project selected as part of the H2020 call HORIZON-CL4-2021-DIGITAL-EMERGING-01.

The approach and structure of the **6GStart** project is designed around creating the new SNS JU infrastructure and facilities while maintaining and operating the existing 5G PPP infrastructure and managing the transition of European ICT research focus from the 5G PPP to the 6G SNS JU. This will be achieved by building on the 5G PPP achievements and bringing the European momentum from Horizon 2020 into the new challenges of the SNS JU under Horizon Europe.

The first major objective of **6GStart** was to prepare the infrastructure and working processes for the SNS JU Initiative<sup>59</sup>, which was contractually established in Q4 2021, so that the new JU could get up to speed quickly and capitalise on the European momentum and leadership in 5G achieved through the 5G PPP to accelerate beyond 5G to enable 6G in Europe by 2030.

When the first phase of projects under the SNS initiative started (Jan 2023), the inter-project collaboration structures and mechanisms will be established and put in place. As such, the action will ensure early implementation of the new SNS institutionalised European partnership and the programmatic organisation across SNS project's coordination.

The second major **6GStart** objective is to orchestrate, capture and promote the achievements of the ongoing 5G PPP by facilitating its activities in the inter-project working groups and maintaining the links to the NetworkWorldEurope community and the 6G-IA membership. During 2023 the majority of 5G PPP projects will be coming to an end so 6GStart should help promote the achievements and success of the 5G PPP initiative as a whole.

The third major goal of the **6GStart** project will be to organise the EuCNC&6GS conferences in 2023 and 2024. These events will significantly contribute to the strategic objectives of promoting the 5G PPP and the SNS JU achievements.

The approach of the 6GStart project will be to support and facilitate major actions during its lifetime such as:

- Extracting strategic R&I orientations from the European ICT community.
- Coordination with 5G/6G R&I results/initiatives at EU scale including Member State level initiatives.
- Establishing and maintaining dissemination structures and web presence for the European ICT initiatives.
- Establishing and organising the EUCNC & 6G Summit (EuCNC&6GS) conference in 2023 and 2024.
- Orchestrating and tracking European projects and programmes contribution to emerging standards.
- Facilitating international cooperation across key regions based on promoting European priorities.
- Developing methodologies for collecting metrics data for the SNS JU.
- Supporting the cross project Working Groups and publishing their main achievements as White Papers.

On average, the **6GStart** project will support over 50 projects running in parallel in each month across the two initiatives, with a substantial peak as the SNS JU projects start and a corresponding decrease as the 5G PPP comes to an end. This picture may change as the second phase of SNS JU projects come on stream and a restructuring of the workplan may be required.

---

59. <http://smart-networks.europa.eu/>



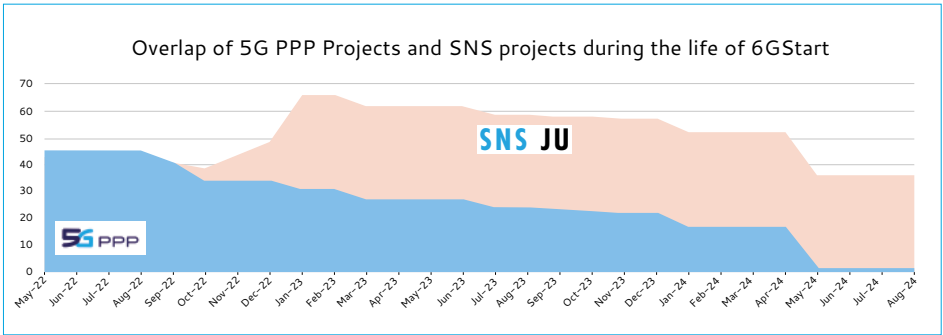

Fig. 57: 5G PPP and SNS-JU programmes

The **6GStart** project objectives reflect and support the formal commitments of the SNS JU contractual arrangement, the working structures of the SNS JU Office and the strategic objectives

of the 6G-IA as they will be the guiding policies of the SNS initiative and, therefore, they are also guiding the high-level ambitions of the **6GStart** project.

# 5G THEMATIC CHAPTER

---

## SME success stories and results from 5G PPP projects

The year 2022 marked the end of the 5G PPP initiative<sup>60</sup>, and the first SNS JU<sup>61</sup> calls for projects. SMEs have already contributed to developing the SNS Partnership, in particular via a dedicated position paper published at the end of 2020<sup>62</sup>. **The evolution from 5G PPP to SNS is an important step for SMEs** (as well as for other project participants), as the SNS ecosystem involves **more and more stakeholders from vertical sectors and from complementary fields** such as AI, IoT, HPC (High-Performance Computing) and others. Every effort was deployed by the NetworkEurope SME Working Group once again to promote the skills and expertise of European SMEs within the newly formed (and evolving) SNS ecosystem. SMEs' interest in this new initiative was demonstrated by the huge increase in the number of SMEs who became 6G-IA members, surging from a dozen in 2021 to 63 in 2022<sup>63</sup>. SME WG member numbers also continued to increase throughout 2022, reaching 241 by the end of the year, including 214 SMEs. This represents an increase of 11% in one year.

**The SNS JU recommends a minimum 20% proportion of SME participation** in upcoming projects, replicating one of the KPIs of the 5G PPP initiative. Unfortunately, SNS Call 1 did not manage to reach this target, peaking at an 18% participation level for SMEs. More small and medium enterprises are expected to become involved at a later stage in several SNS Call 1 projects, which include open calls, and to increase the future proportion of SME participation.

To promote further promote SME participation in the upcoming SNS call 2 planned for 2023, **a new update of the SME-related web pages<sup>64</sup> was finalised in late 2022, along with a new edition of the "European SME Expertise in 5G and Beyond" brochure<sup>65</sup>**. Eighty one SMEs are now present both on the web and in the brochure, representing an increase of 17% since the previous edition.

**Many new SME success stories** were published in 2022, demonstrating the significant results that SMEs have achieved from their participation in 5G PPP projects.

As a result of their participation in the 5G HEART and 5G TOURS projects, **Azcom Technology** of Milan, Italy, has installed network monitoring probes and a cloud-based management system. This creates the ability to measure 5G network performance KPIs, such as throughput, latency, jitter, loss, availability and reliability, both end-to-end and in segments of the network (radio vs. core, physical vs. service layer, E2E vs. segments of interest to the operator).

**CyberEthics Labs**, another Italian SME, has developed an innovative research and assessment methodology for the Social Acceptance of Technologies, which includes involving all the stakeholders, from developers to users, and aims to support them in integrating psychological, economic, legal, ethical and political values from the very beginning of the design process of new products and systems. This Responsible Research & Innovation approach was integral to the 5G-SOLUTIONS project, through which CyberEthics Labs defined and tested its own social acceptance of 5G technology methodology.

Thanks to their contribution to 5G PPP projects such as FUDGE-5G, Fivecomm of Valencia, Spain, has developed the 5G BROAD router, designed to connect user devices to 5G networks via Ethernet or USB. It comes with an open operative system based on OpenWRT, a Linux operating system targeting embedded

---

60. <https://5g-ppp.eu/>, 5G PPP projects are still ongoing, but the calls for projects have been completed.

61. <https://smart-networks.europa.eu/>

62. "SME WG SNS Position Paper", 4 November 2020, <https://www.network-europe.eu/wp-content/uploads/2020/12/sme-wg-sns-position-paper-final.pdf?x70854>

63. The list of SME members of 6G-IA can be found at <https://6g-ia.eu/sme/>. A few SMEs are also associate members of 6G-IA (cf. <https://6g-ia.eu/associates-members/>).

64. <https://www.networkeurope.eu/sme-wg/>, <https://www.networkeurope.eu/find-the-sme-you-need-new-page/>

65. <https://bscw.5g-ppp.eu/pub/bscw.cgi/d518320/2022-sme-brochure-final.pdf>

devices, that allows any user to configure and make changes easily.

As part of the VITAL-5G project, the work of **Intelligent**, a Greek company from Athens, helped expand their product/service line to include other relevant vertical sectors of interest, namely customs, and deliver advanced data ingestion and ML/AI capabilities tailored to the needs of those verticals.

Thanks to their contribution to the 5G-LOGINNOV project, **Internet Institute**, an SME from Ljubljana, Slovenia, has successfully developed and verified their Industrial IoT Gateway. This appliance ensures secure, resilient and QoS guaranteed 5G connectivity for IoT devices such as various environmental sensors, industrial sensors and cameras.

The Swiss SME **Martel**, of Zurich, contributed to enhancing the Open Source MANO (OSM) for flexible cloud-native service deployments, developed within the Affordable5G project. OSM, an Open Source community-driven management and orchestration platform for Virtualised Network Functions (VNFs), is being used in the Affordable5G project as an orchestrator for Cloud to Edge, 5G-centric services.

As part of the same Affordable5G project, **Nearby Computing**, an SME from Barcelona in Spain, is offering their flagship cutting-edge NearbyOne Edge Orchestrator to one of the project's pilot trials, to provide network and service orchestration. Their work on zero-touch network and service management was singled out by European Commission's Innovation Radar, which has analysed and highlighted their end-to-end intelligent orchestration and slice management (carried out jointly with Acceleran and i2CAT) as a "key innovation" that addresses the needs of existing markets.

The work of **Nemergent Solutions** from Bilbao, Spain, as part of the 5G-EPICENTRE project, in partnership with Athonet of Italy and One Source of Portugal, and with an academic partner providing a 5G testing platform, is devoted to Public Protection and Disaster Relief (PPDR) network applications and associated capabilities. Thanks to the direct interaction between MCX network applications and the 5G Core Network, it is possible to guarantee the QoS conditions required for this type of solution both for default traffic and specific traffic, via

direct and dynamic requests to the 5GC's Policy Control Function or Network Exposure Function.

Thanks to their participation in INSPIRE-5GPlus, **Solidshield** from Le Cannet, France, has broadened its horizons, providing its solution with off-core functionalities. One key development builds on its stand-alone "Harden-and-Forget" software security and continuous remote monitoring capacity. In short, the protected software execution is constantly monitored at a central utility, regardless of the security hardening measures that are already in place. This remote monitoring meshes perfectly with any telecom industry software and is never isolated from the rest of the network.

All these success stories demonstrate not only **SMEs' strong involvement of in 5G PPP projects**, but also the **powerful impact that 5G PPP projects have had on the development of products and solutions in many SMEs from across Europe**.

*Three hundred and sixty one SMEs are members of NetworkEurope, the European Technology Platform for telecommunications and related services and applications. The SME WG is part of NetworkEurope, and has strong links and a continuous interaction with the 6G Infrastructure Association (6G-IA). The current SME representatives on the 6G-IA Board are Nicola Ciulli from Nextworks, and David Kennedy from Eurescom. There are five SME representatives on the NetworkEurope Steering Board: Montimage, Nextworks, Quobis Networks, RFSAT, and Ubiwhere. The SME WG is chaired by Jacques Magen from AUSTRALO, and Nicola Ciulli from Nextworks is Vice-Chair. It is supported by the 6GStart Coordination and Support Action. More information is available at <https://www.networkeurope.eu/sme-wg/>. The "Find your SME" web page is available at <https://www.networkeurope.eu/find-the-sme-you-need-new-page/>. The latest edition of the SME brochure can be downloaded at <https://bscw.eu/pub/bscw.cgi/d518320/2022-sme-brochure-final.pdf>.*

## SCoDIHNet activities

The Smart Connectivity Digital Innovation Hub Network (SCoDIHNet) seeks to facilitate the adoption of the 5G and IoT technologies and to contribute to the digitalisation of European Industry, which is part of the next Digital Europe Program (DEP). The SCoDIHNet initiative is helping companies to improve their processes,

products and services through the use of smart connectivity technologies.

To this end, *SCoDIHNet* supports all DIHs (Digital Innovation Hub) addressing Smart Connectivity technologies (5G/6G, IoT, Edge, Cybersecurity and AI). By the end of 2022, the *SCoDIHNet* had built a community of more than 90 DIHs in Europe.

The *SCoDIHNet* initiative is supported by AIOTI<sup>66</sup> and the 6G-IA. 5G and IoT are indeed key technologies to developing European industry digitalisation. AI and cybersecurity are also vital technologies, ensuring flexibility, adaptability, and end-to-end security.

In 2022, the core purpose of *SCoDIHNet* was to establish cooperation among members and with sister organisations in order to bring DIHs in the most efficient ecosystem. To this end, *SCoDIHNet* signed multiple MoUs and initiated cooperating with a large number of organisations:

- MoU signed with the Enterprise Europe Network<sup>67</sup>: European SMEs
- Cooperation with the European Business and Innovation Centre Network<sup>68</sup>
- Cooperation with the Horizon Result Booster<sup>69</sup> & Horizon Result Platform<sup>70</sup>: Replicability and reuse of existing solutions
- Cooperation with the DIH4Industry network<sup>71</sup>: DIHs network for manufacturing
- Liaison with the Digital Transformation Accelerator<sup>72</sup>: the project in charge of coordinating all EDIHs (European DIH)
- MoU signed with the African DIH networks: best practices exchange with African DIHs
- Cooperation with the Centre for Innovation Management Research<sup>73</sup>: IoT technology watch

- Contribution to the OpenDEI project<sup>74</sup> : Contribution to the task force in charge of DATA-POWERED BUSINESS ECOSYSTEM BUILDING to Foster collaboration, business interoperability between stakeholders
- Cooperation with the DIH4AI network<sup>75</sup>: Artificial intelligence DIHs network
- Liaison with the Partnerships for Regional Innovation<sup>76</sup>: 63 regions, seven cities and four Member States selected for Pilot Action
- Cooperation with the Connecting European Facilities/5G For Smart Communities<sup>77</sup>: sharing 5G infrastructures with DIHs in order to accelerate development of innovations at local level
- Cooperation with the European Startup Nation Alliance<sup>78</sup>: including Startups in DIHs local ecosystems
- Cooperation with the EVOLVED-5G project<sup>79</sup>: 5G startup support

Moreover, *SCoDIHNet* and the 5G Trial working group are collaborating to identify replicable use cases and solutions developed and trialled by 5G PPP projects. A replicability catalogue which contains 117 use cases/solutions from 28 projects is available for reuse to DIHs.

*SCoDIHNet* is also contributing to SME business development. Digital Innovation Hubs aim to facilitate cooperation at the regional level and help European Industry digitalisation. A mapping of technology providers belonging to Smart Connectivity clusters (NetworldEurope, 6G-IA, AIOTI, EEN, ESNA) and DIHs has been developed. It will bolster cooperation at local level between end users (DIH customers) and SMEs.

In 2023, *SCoDIHNet* will focus mainly on kick-starting DIHs operational activities. It will help DIHs to develop or adapt existing solutions to end-users' needs and requirements through cooperation and additional funding. It will also create an opportunity to collect additional requirements from end users to feed the 6G strategic agenda.

---

66. [www.aioti.eu](http://www.aioti.eu)

67. <https://een.ec.europa.eu/>

68. <https://ebn.eu/>

69. [www.horizonresultbooster.eu/](http://www.horizonresultbooster.eu/)

70. <https://ec.europa.eu/info/funding-tenders/opportunities/portal/screen/opportunities/horizon-results-platform>

71. <https://dih4industry.eu>

72. <https://www.edihnetwork.eu/home>

73. <http://www7.bbk.ac.uk/cimr/>

---

74. <https://www.opendei.eu/>

75. <https://www.dih4ai.eu/>

76. [https://ec.europa.eu/regional\\_policy/en/newsroom/news/2022/05/17-05-2022-partnerships-for-regional-innovation-63-regions-seven-cities-and-four-member-states-selected-for-pilot-action](https://ec.europa.eu/regional_policy/en/newsroom/news/2022/05/17-05-2022-partnerships-for-regional-innovation-63-regions-seven-cities-and-four-member-states-selected-for-pilot-action)

77. <https://digital-strategy.ec.europa.eu/en/activities/5g-smart-communities>

78. <https://esnalliance.eu/>

79. <https://evolved-5g.eu/>

## The EC H2020 5G Infrastructure PPP

The 5G Infrastructure Public Private Partnership (PPP) Programme comprises several funded projects organised in three distinctive phases, namely specification, development and experimentation/pilots. It is slowly coming to its conclusion.

The 5G Infrastructure PPP Programme entered in its final phase (phase 3) in 2018 with the selection of Part 1: infrastructure projects. The 5G PPP programme is nearing the end and is currently in its final months of existence. 5GPPP projects nevertheless continued their impressive work during 2021–2022, providing key results and significant achievements for 5G networks and their evolution. Phase 1 and 2 projects were closed during 2020. Phase 3 Parts 1 and 2 projects are no longer running, as all six projects ended in 2021. Among the eight Phase 3 Part 4: 5G Long Term Evolution projects which began operations in 2019, only a few are still running and all expected to wrap up their activities in 2023. The eleven Phase 3 Part 5: 5G Core Technologies Innovation and 5G for Connected and Automated Mobility (CAM) projects which began operating in 2020 will also reach full completion in 2023.

Moreover, the last group of 19 projects which got underway in 2021, on Innovations for verticals with 3<sup>rd</sup> party services and Smart Connectivity beyond 5G, will wind up their activities in either 2023 or 2024. Work on Innovations for verticals accelerated the pace of 5G take-up in vertical sectors. Work on Smart Connectivity beyond 5G covers the long-term transformation of networks into a distributed smart connectivity platform with high integration of (edge) computing and storage resources and which supports virtually infinite capacity, including a perceived zero latency, a very high number and variety of devices e.g., in cars, doors, mirrors, appliances and very high reliability and availability. New interfaces for recognising gestures, facial expressions, sound, and haptics should also be implemented.

In all, 46 projects were active in 2022, dropping declining to 25 in the second half 2023 and to 20 by December 2023 – out of the 93 projects that have been or are contractually active in the 5G PPP programme to date, creating a dynamic environment and strong momentum.

5G PPP phase 3.1 included three infrastructure-related projects. They all started up in 2018 and provided large-scale end-to-end 5G validation network infrastructures, covering 20 sites and nodes in Europe until 2021. They fulfilled their role perfectly and enabled testing of innovative 5G use cases.

As part of phase 3.2, the three automotive projects tested advanced cross-border scenarios for autonomous driving, and provided collective results in White Papers.

Eight projects were part of the 5G PPP phase 3.3. They demonstrated advanced 5G validation trials across multiple vertical industries: industry 4.0, smart cities and utilities, smart airports or ports, energy, media and entertainment, public safety, eHealth and wellness, transport and logistic, automotive, agriculture and agri-food.

Under phase 3.4, eight projects have been working on the longer-term vision for telecommunication networks. A major focus for evolved networks is reducing network energy consumption. In low-power networks, processes and applications will be managed dynamically, based on customer needs and traffic flows. AI/ML, sound and haptics will help humans and infosystems interact.

The main achievements and results of 5G PPP phases 1<sup>80</sup> and 2 were published at the end of each phase, highlighting more than 100 results classified by program levels achievements, most of which were technological breakthroughs. Following through, 5G PPP phase 3 key achievements v3.0<sup>81</sup> from Phase 2 and Phase 3 projects reported approximately 80 achievements classified in 11 categories. Most pertain to trials in ten distinct vertical sectors or to more advanced work in 5G architecture and network management. The Phase 2 and Phase 3 projects have validated, trialled, and piloted 5G technology in a wide range of vertical sectors (e.g., Automotive, Industry, Media & Entertainment, Public Safety, Health, Energy, Smart Cities, Transport & Logistics, etc.). This list of 5G PPP phase 3 key achievements was updated in the Key achievements 3.1 catalogue of more than 100 outcomes, classified by 20 program level achievements. This includes the latest accomplishments from 5G PPP phase 3.4: 5G long-term Evolution

80. <https://5g-ppp.eu/phase-1-key-achievements/> and <https://5g-ppp.eu/phase-2-key-achievements/>

81. <https://5g-ppp.eu/key-achievements-v3/>

projects and completed results from phase 3.3: Advanced 5G Validation trials across multiple vertical industries projects. The list was further updated to highlight 129 outcomes from phase 3

projects classified by 20 program level achievements. As shown in Figure 58, most of the results again relate to trials in vertical sectors.

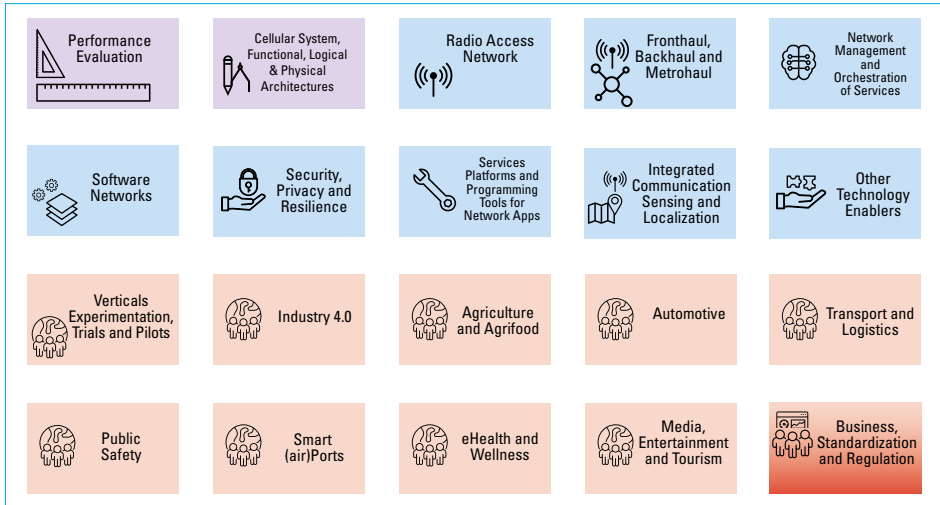

Fig. 58: 5G PPP key achievements 3.2

Since 2020, efforts have been made to collect data from test and field trials in vertical sectors to validate the fact that 5G provides greater flexibility in the deployment of services with widely diverse characteristics and service levels. These distinct services can take advantage of 5G and be implemented over different network slices.

Building on older brochures released in September 2019 and December 2020, the Trials and Pilots brochure No. 3 published in 2021<sup>82</sup>, released 10 additional Phase 2 and Phase 3 Trials and Pilots. These 10 T&P have been evaluated by a panel of experts and selected from over

25+ candidates, based on a set of pre-defined criteria (impact of 5G networks, achieved KPI, technology and market readiness levels, societal impact, 5G empowerment etc.). Building on trials and pilots' brochures, the Automotive Working Group released its own brochure: "Trials and Pilots for Connected and Automated Mobility"<sup>83</sup> in August 2021. It provides a schematic and visual summary of the key use cases, key performance indicators and trials and pilots conducted by the Phase 3.2, 3.5 and 3.6 projects dedicated to enabling efficient and reliable 5G-V2X communications for CAM.

82. <https://5g-ppp.eu/layer-brochure/>

83. <https://5g-ppp.eu/trials-and-pilots-for-connected-and-automated-mobility/>





# 5G EVENTS

---

This past year has been rich in events, cooperation agreements, workshops, and White Papers. This section provides a global overview and reports on major milestones.

## 5G/6G initiatives to date

The European Commission promotes international cooperation and seeks to reach a global consensus on the development of mobile standards and requirements, and especially on 5G and 6G. To this end, agreements have already been signed with many other regions around the globe to support 5G deployment and adoption. Similar agreements are being signed on 6G.

In 2015, the 5G Infrastructure Public Private Partnership, 5G PPP, inked partnerships with similar 5G programs outside Europe. From June 2014 to April 2018, MoUs were signed between 5G PPP and peer organisations throughout the world, including the 5G Forum in South Korea in June 2014, 5G Americas in the US and the 5GMF in Japan in March 2015, the IMT-2020 (5G) Promotion Group in China in September 2015, Telebrasil in Brazil in March 2017 and TSDSI in India in April 2018.

5G-related MoUs are being extended or renewed for 6G context to maintain the cooperation. The MoU signed between the Beyond 5G Promotion Consortium and the 6G-IA in May 2022 will further promote cooperation beyond 5G/6G. The two parties agreed to exchange information and cooperate on several matters, such as their vision of 6G and requirements, technology and information dissemination to raise awareness, understanding and stimulate involvement, and finally adoption, discussions on basic system designs, architecture and use cases, support for global regulatory processes for the identification of frequency bands and spectrum arrangements for 6G technologies, identification of common interests, consensus building and collaboration to support the development of globally harmonised standards, promoting cooperation amongst European and Japanese R&D organisations and industries.

In June 2022, the 6G-IA and the IMT-2030 (6G) Promotion Group signed an MoU on 6G, renewing their previous MoU on 5G which was signed back in 2015. They agreed to share information and to collaborate in the field of 6G communication systems and networks, and to organise joint activities, including workshops, seminars, webinars, trials and joint publications.

AENEAS Industry Association<sup>84</sup> and the 6G-IA also signed an MoU to strengthen communication and cooperation between them, with the common objective of contributing to Europe's leadership and technological sovereignty beyond 5G and 6G networks and services, by building a strong European Electronic Components & Systems (ECS) industry. Key actions include hosting events such as conferences and webinars that focus on SMEs and opportunities for participation in EU national and transnational R&I funding instruments. They also explore possible future coordination amongst funding instruments, and work to increase cross-fertilisation and mutual contributions to strategic research and innovation agendas, as well as the promotion of cross-cutting projects whenever feasible (e.g., EUREKA Clusters).

Two months later, in August 2022, the 5G Automotive Association (5GAA)<sup>85</sup> and the 6G-IA signed an MoU as a result of their mutual interest in strengthening the liaison between EU-funded projects on V2X and Connected and Automated Driving (CAD) with the relevant industry players, along with their wish to ensure the successful exploitation of V2X and CAD EU-funded project results. Under this MoU, both parties agreed to cooperate for the benefit of the connected and automated mobility sector and society as a whole.

---

<sup>84</sup>. AENEAS is an Industry Association, established in 2006. The purpose of the association is to promote Research, Development and Innovation (RD&I) in order to strengthen the competitiveness of European industry across the complete Electronics Components and Systems (ECS) value chain - <https://aeneas-office.org/>

<sup>85</sup>. The 5G Automotive Association (5GAA) is a global, cross-industry organisation of companies from the automotive, technology, and telecommunications industries (ICT), working together to develop end-to-end solutions for future mobility and transportation services - <https://5gaa.org/>

## Global 5G events

**EuCNC 2022** was held in June 2022. The conference focused on various aspects of 5G and 6G communications systems and networks, including cloud and virtualisation solutions, management technologies, hardware components and microelectronic technologies, and vertical application areas. Research projects, from successive European RDI programmes such as Horizon 2020, were able to demonstrate results and main achievements.

More than 30 European projects were brought to Grenoble (France) to present results, progress, videos and demos. They included: TERAWAY (*"Photonic integration as a key enabling technology for 6G and beyond"*), CORENect (*"Policy workshop and workshop on key findings of Expert Groups"*), HEXA-X (*"The 6G workshop series by Hexa-X"*), TeraFlow (*"Redesigning Transport Networks for 6G: From the cell site to the core"*), Smart5Grid (*"Network Applications for Verticals"*) held workshops or special sessions. Many projects had a booth and hosted interesting discussions and demos took place.

- Elements from the DEDICAT 6G use cases were showcased and demonstrated including robots and AR applications for Smart Warehousing, AIRBUS Mission Critical application for Public Safety, OPTINVENT Smart glasses for Enhanced Experience and Smart Highway.
- 6G-BRAINS presented a testbed video presentation on mmWave uplink test and indoor visible light positioning testbed.
- MonB5G demonstrated novel autonomic management and orchestration framework of MonB5G, heavily leveraging the distribution of operations together with state-of-the-art data-driven AI-based mechanisms. More specifically, two main demos – namely PoC-1 Zero-Touch Network and service management with end-to-end SLAs and PoC-2 AI-assisted policy-driven security monitoring and enforcement – were demonstrated to show the scalability and security implementation solutions of network slicing, management and orchestration of telecommunication networks in the field of 5G.
- The FUDGE-5G demonstration focused on its platform, which implements the Service Communication Proxy and offers cloud-native location-aware orchestration of 5G Cores.
- Affordable5G showcased its latest project outcomes and developments in its quest to create a high-tech and affordable 5G network roll-out spanning across several fields.
- The5G-MOBIX exhibition booth promoted the project and its use cases/user stories and show videos of past demonstrations at different trial sites (the Netherlands, Germany, Finland, etc.) on the booth's screen.
- 5G-CARMEN presented the key findings and results collected through live pilots performed along the highway corridor connecting Bologna to Munich, with focus on activities performed at the borders between Italy and Austria, and Austria and Germany.
- 5GCroco visitors could control a virtual vehicle (by means of a game controller) that can interact with other cars.
- 5GZORRO proposed demonstrations aiming at showcasing several capabilities in support of a telecom marketplace for trading and acquiring multi-provider 5G product offers, with smart contracts based on DLTs, and AI operations through cross-domain zero-touch service, network and security management.
- 5G-SOLUTIONS presented several demonstrations, both on-site and remotely connected. One of the main topics was the demonstration of the use case devoted to Ultra High-Fidelity (UHF) Media which addresses the full set of the 5G-SOLUTIONS enablers.
- 5G COMPLETE showcased a video on the spawn of simple containers servicing a static HTML page on diverse nodes. Additionally, it contains the early integration of hardware acceleration functionality in serverless computing via an image classification operation running as an OpenFaaS function on the 5G-COMPLETE systems software stack.
- 5G-VICTORI showed how open and multi-technology 5G infrastructures can be exploited in support of vertical industry requirements and services offering a suitable environment not only in support of service delivery, but also of sharing required resources and functions in a controlled and secure framework.

- 5G-TOURS brought posters, videos and demonstrations for use cases in the tourism, health and transportation sectors.
- The 5G!Drones Project consortium showcased and demonstrated various scenarios of how 5G technology can leverage UAV (Unmanned Aerial Vehicle) operations. Some of the demonstrations included: BVLOS (Beyond Visual Line of Sight) medical delivery over 5G network, use of UAVs & 5G technology for search and rescue operations, Airbus Mission Critical Systems over 5G, and we will also show how the KPIs for 5G can be applicable to UAV industry.
- ARIADNE showcased a demonstration based on a combination of tools including a data science platform owned by RapidMiner, commercially available mathematical tools and open platforms for ML training.
- 5G-CLARITY showed main results and outcomes. The demo considered 5G NR, WiFi-6, and LIFI technologies integration into a 5G-CLARITY CPE designed to be placed in mobile devices requiring high bandwidth and resiliency while navigating through public and private networks.
- 5G-IANA presented use cases.

**The 9th Global 5G Event**, to support multilateral collaboration on 5G systems across countries and territories, was organised in person in Tokyo on 20 and 21 September 2022. It is the result of a multilateral Memorandum of Understanding signed between 6G-IA (EU), 5G Americas, 5G Forum (Korea), 5G MF (Japan), 5G Brasil, IMT-2020 (China) and TSDSI (India), in order to build a global consensus on 5G. Different topics were addressed such as 5G regulations and policies, 5G business trend on commercialisation, 5G network development and installation for advanced 5G and prospects from 5G to beyond 5G.

**MWC, or Mobile World Congress**, is considered the most significant international summit of the mobile connectivity industry in Barcelona. Over 61 000 attendees from 168 countries have gathered in Barcelona to explore the latest trendsetting connectivity technology, foster valuable B2B connections and gain insight into the solutions to the current challenges to cross-industry connectivity. MWC 2023 was organised around five themes, including, 5G Acceleration, Reality+, OpenNet, Digital Everything, and FinTech. Exhibiting companies were present from various backgrounds, on the forefront are influential tech and mobile providers, supplemented by device manufacturers, vendors, and content owners. The exhibition was arranged through Digital planet, Company Spotlights, Industry City sections giving each influential player in the telecom ecosystem maximum exposure prospects. Experts, keynote researchers presented at MWC 2023, headlining forums, conference sessions and speeches bringing valuable insight into all aspects of connectivity and digital media. The MWC dynamic display was followed up with valuable networking and informative events on 5G Connect, Advancing AI, CloudNet and other essential topics.

At the Mobile World Congress Barcelona 2023, several projects had a booth or shared a booth. The two H2020-ICT-52 5G PPP Smart Connectivity beyond 5G projects DAEMON and AI@EDGE shared a stand. MonB5G was present at the CTTC booth. FUDGE 5G also had a booth. 5GMED hosted a panel on: *“Europe and Spain facing the connected mobility challenge”* introduced by the Spanish 5G Observatory.

Partner Instituto de Telecomunicações/ Universidade de Aveiro organised a NetworkEurope / CCSA workshop in parallel with MWC 2023 entitled Metaverse on the move.

At last, a number of the 6Gstart partners attended the MWC event.



# OTHER EVENTS AND INITIATIVES

---

## Workshops and webinars

5G PPP and the 5G IA/6G-IA also organised major workshops in 2022. Some of them are listed here.

In February 2022, Hexa-X organised a workshop together with other ICT-52 6G projects: the European projects HEXA-X, REINDEER, TeraFlow, 6G-BRAINS, MARSAL, DAEMON, COREnect, AI@EDGE, RISE-6G and B5G-OPEN took part in the workshop. The workshop covered a wide variety of topics, testifying to the ambition, progress and capabilities, and provided key conclusions and recommendations on 6G.

In April 2022, 5GMEDIAHub organised a webinar on the 5G Experimentation Environment for 3<sup>rd</sup> party media services, 5GCroco held its 2<sup>nd</sup> lunchtime webinar in 2022 on precise positioning for Connected and Automated Mobility Services. The first 5GCroco webinar was an *“Overview of Privacy Aspects to consider for the Anticipated Cooperative Collision Avoidance Use Case”*.

5G-LOGINNOV, FUDGE 5G and Affordable 5G co-hosted a technical workshop on *“Challenges and Opportunities for Private Networks focusing on CAD, Transport and Logistics, Smart City, Manufacturing”* in June 2022. This workshop addressed technology-specific topics and opened up discussions on accelerating 5G innovation in Europe.

In June 2022, the Vision and Societal Challenges Working Group’s Societal Needs and Value Creation Sub-Group hosted a Webinar to present its latest White Paper *“What societal values will 6G address? – Societal Key Values and Key Value Indicators analysed through 6G use cases”*<sup>86</sup>.

Also in June 2022, the Smart5Grid Consortium organised the webinar on *“5G Use Cases for the Energy Vertical”* and discussed four use cases.

The COREnect project is developing a 5G/6G strategic roadmap for future European connectivity systems and components. Two workshops are organised in June 2022 to discuss the various aspects of this roadmap, including the COREnect Policy Workshop.

The 5G PPP Test Measurement and KPI Validation work group (TMV WG) held a workshop to reflect on 6G KPIs and how to measure them based on its White Paper, *“Beyond 5G/6G KPIs and Target Values”*<sup>87</sup>.

In December 2022, 5G-IANA conducted its first webinar titled *“Bridging the gap between the 5G-IANA platform developers and the use case NetApp/VNF developers”*.

A Collaboration Innovation Day was co-hosted by 5G-LOGINNOV and ALICE in October 2022. This event was aimed at demonstrating how 5G is a revolution for the logistics sector in Europe and 5G is driving technology innovation in transport and logistics. Emerging 5G business opportunities and models were also studied.

On 18<sup>th</sup> October 2022, the Hexa-X project will be part of the event Network X – Connectivity Redefined Cloud Reimagined Telco Reinvented ([networkxevent.com](http://networkxevent.com)) in Amsterdam with a workshop involving international stakeholders on 6G as part of Broadband World Forum.

In November 2022, 5G-SOLUTIONS initiated a seminar on *“Co-creation for 5G solutions in Industry and Media”* and invited 5G-VICTORI and 5G-MEDIAHub to contribute and share views from experiments, trials and collaboration. The main topics of discussion were: 5G solutions and experimentation for advanced industry, 5G solutions and experimentation for advanced Media, and how a 5G network operator can facilitate experimentation.

Also in November 2022, the 5G vertical users workshop sought to hold a collaborative event for strategic dialogue between vertical industries (automotive Industrial automation, health, media industry, security, public safety, energy) and 3GPP, by exchanging requirements, exploring

---

86. <https://5g-ppp.eu/wp-content/uploads/2022/05/What-societal-values-will-6g-address-White-Paper-v1.0-final.pdf>

87. [https://5g-ppp.eu/wp-content/uploads/2022/06/white\\_paper\\_b5g-6g-kpis-camera-ready.pdf](https://5g-ppp.eu/wp-content/uploads/2022/06/white_paper_b5g-6g-kpis-camera-ready.pdf)

common requirements, and looking at upcoming future standards development. The workshop provided a unique opportunity for vertical industries to share their future requirements, but also to outline issues, and obstacles to progress.

In 2022, 5GZORRO held three technical talks (January: current landscape for AI/ML applications for networking, March: the future of multistakeholder 5G networks, June: *“Enabling data-driven automation for 5G and beyond”*). It delved deep into questions related to technology enablers for emerging 5G/6G data architectures and listened to opinions on how data-related topics, including support for data modelling, sharing, processing, storing, etc., are manifested in complex multi-provider business settings and multi-domain technology environments of 5G/6G networks.

## White Papers and reports

In 2022, several White Papers and reports were produced by projects and 5G PPP Working Groups. All White Papers are publicly accessible via the 5GPPP website<sup>88</sup>. An overview is provided below.

- The *“6G Architecture Landscape – European perspective”* White Paper released by the 5G Architecture Working Group in December 2022, summarizes the findings from the European research landscape on the first version of the 6G architecture. This includes the various technical enablers as well as the first End-to-End system and functional view of the 6G architecture structure.
- The *“Non-public Networks – State of the art and way forward”* White Paper released by the 5G PPP Technology Board in November 2022 presents the state of the art of NPNs in the 5G and beyond 5G context, and provides an outlook on possible development paths for this concept.
- The INSPIRE-5Gplus project published the *“Intelligent Security Architecture for 5G and Beyond Networks”* White Paper in October 2022. It introduces the updated

version of the overall INSPIRE-5Gplus framework’s High-Level Architecture, describing its main functional blocks, the key security management services provided by the functional blocks and their role in empowering intelligent closed-loop security operations. The *“Network Applications: Opening up 5G and beyond networks”* White Paper from the 5G PPP Software Network Working Group was released in September 2022. It aims to demystify the concept of the Network Applications by summarising and categorising different ICT-41 projects and some projects from ICT-52 and ICT-42.

- The *“From 5G to 6G Vision – A Connected and Automated Mobility (CAM) perspective”* White Paper was publicly released in June 2022. The paper reflects on the lessons learned during the execution of the key 5G PPP projects focusing on 5G for CAM and contributing to identify from the very beginning, new mobility requirements for the evolution of 5G and 6G communication systems. It also identifies the impending new technologies that are being considered for 6G and have the potential to have a highly positive impact on CAM.
- The June 2022 *“Beyond 5G/6G KPIs and Target Values”* White paper presents the current view of the available B5G and 6G KPIs from the 5G PPP phase III projects with an emphasis on the views of the ICT-52 Smart Connectivity Beyond 5G projects. This overview includes mapping the KPIs previously defined for 5G and evaluating how they might evolve to fit the B5G and 6G visions.
- The *“What societal values will 6G address? – Societal Key Values and Key Value Indicators analysed through 6G use cases”* White Paper was prepared by the Societal Needs and Value Creation Sub Working Group in June 2022. It outlines how a technology development driven from the perspective of societal values can complement the usual performance-driven perspective. A set of use case areas, representing new possibilities opened up by 6G, are identified from published sources, chiefly EU-funded ICT-52 research projects.

---

88. <https://5g-ppp.eu/white-papers/>



## Appendix 1: working groups

Working Groups	Origin
<b>5G Architecture</b> Ömer Bulakci, Nokia Xi Li, NEC	5G PPP projects
<b>5G for CAM</b> Jesus Alonso-Zarate, i2CAT Markus Dillinger, Huawei Edwin Fischer, Deutsche Telekom	6G-IA
<b>Pre-Standardisation</b> Ricardo Trivisonno, Huawei Francisco Osimanti, Trust-IT	6G-IA
<b>Spectrum</b> Giovanna D’Aria, Telecom Italia	6G-IA
<b>Security</b> Pascal Bisson, Thalès Antonio Skarmeta, University of Murcia	6G-IA
<b>Trials</b> Carles Antón-Haro, CTTC	6G-IA
<b>Vision and Societal Challenges</b> Artur Hecker, Huawei Håkon Lønsethagen, Telenor	6G-IA
<b>Open Smart Networks and Services</b> Aitor Garcia, Vodafone	6G-IA
<b>Software Networks</b> Bessem Sayadi, Nokia Marius Iordache, Orange	5G PPP Projects
<b>Test, Measurement and KPIs Validation</b> Evangelos Kosmatos, WINGS ICT Michael Dieudonne, Keysight	5G PPP Projects
<b>SatCom</b> Tomaso de Cola, DLR	NetworldEurope
<b>SME</b> Jessica Carneiro, AUSTRALO Nicola Ciulli, Nextworks	NetworldEurope
<b>Verticals Task Force</b> Raffaele De Pepe, Telecom Italia	6G-IA
<b>Expert Advisory Group</b> Ari Pouttu, University of Oulu Jyrki Huusko, VTT	NetworldEurope



# Appendix 2: acronyms and abbreviations

<b>3GPP</b>	Third Generation Partnership Project	<b>CEF</b>	Connecting Europe Facility	<b>FWA</b>	Fixed Wireless Access
<b>5G</b>	5 <sup>th</sup> Generation Wireless Systems	<b>CEPT</b>	European Conference of Postal and Telecommunications Administrations	<b>G5GE</b>	Global 5G Event
<b>5G HEART</b>	5G Health AquacultuRe and Transport	<b>CF</b>	Cell-free	<b>GLOSA</b>	Green Light Optimised Speed Advisory
<b>5G PPP</b>	5G Public Private Partnership	<b>CI/CD</b>	Continuous Integration / Continuous Deployment	<b>gNB</b>	Next generation Node B
<b>5G SA</b>	5G Standalone	<b>CMOS</b>	Complementary Metal Oxide Semiconductor	<b>GSA</b>	Global Mobile Suppliers Association
<b>5GAA</b>	5G Automotive Association	<b>CNF</b>	Cloud Native Functions	<b>H2020</b>	Horizon 2020
<b>5G-ACIA</b>	5G Alliance for Connected Industries and Automation	<b>CO2</b>	carbon dioxide	<b>HE</b>	Horizon Europe
<b>5G-IA / 6G-IA</b>	5G/6G Infrastructure Association	<b>CPE</b>	Customer Premises Equipment	<b>HLA</b>	5G New Radio
<b>5GMF</b>	5 <sup>th</sup> Generation Mobile Communications Promotion Forum	<b>CPU</b>	Central Processing Unit	<b>HLA</b>	High Level Architecture
<b>6G</b>	6 <sup>th</sup> Generation Wireless Systems	<b>CSA</b>	Coordination and Support Action	<b>HMI</b>	Human-machine interface
<b>AaaS</b>	Analytics as a Service	<b>CSP</b>	Communication Service Providers	<b>HPC</b>	High Performance Computing
<b>ADCs</b>	Analog-to-Digital Converter	<b>D2D</b>	Device-to-Device	<b>HTC</b>	Holographic-Type Communications
<b>AE</b>	Analytic Engine	<b>DAC/ADC</b>	Digital to Analog Converter / Analog to Digital Converter	<b>IA</b>	Innovation Action
<b>AI</b>	Artificial Intelligence	<b>DCET</b>	Dynamic Control loop for Environment sensitive Traffic management actions	<b>IC</b>	Integrated Circuit
<b>AiP</b>	Antenna-in-Package	<b>DCs</b>	Data centres	<b>ICT</b>	Information and Communication Technology
<b>AMF</b>	Access and Mobility Management Function	<b>DDoS</b>	Distributed Denial of Service	<b>IEM</b>	In-Ear Monitoring
<b>AP</b>	Access Point	<b>DE</b>	Decision Engine	<b>IETF</b>	Internet Engineering Task Force
<b>API</b>	Application Programming Interface	<b>DEP</b>	Digital Europe Program	<b>IIoTT</b>	Industrial IoT with Cloudification
<b>AR</b>	Augmented Reality	<b>DIH</b>	Digital Innovation Hub	<b>IM</b>	Information model
<b>ATO</b>	Automatic Train Operation	<b>DL</b>	Download	<b>ION</b>	Intelligent Operation Network
<b>ATP</b>	Automatic Train Protection	<b>DLT</b>	Distributed Ledger Technology	<b>IoT</b>	Internet of Things
<b>ATPC</b>	Automatic Transmit Power Control	<b>DRL</b>	Deep Reinforcement Learning	<b>ISM</b>	In-Slice Management
<b>AWGR</b>	Arrayed Waveguide Grating Router	<b>D-RoF</b>	Digitalised radio-over-fibre	<b>ITU</b>	International Telecommunication Union
<b>B5G</b>	Beyond 5G	<b>DT</b>	Digital Twin	<b>KPI</b>	Key Performance Indicator
<b>BBU</b>	Baseband Unit	<b>DU</b>	Distributed Unit	<b>KVIS</b>	Key Value Indicators
<b>BICMOS</b>	Bipolar-CMOS	<b>E2E</b>	End-to-end	<b>LoI</b>	Letters of Intent
<b>BSCW</b>	Basic Support for Cooperative Work	<b>EaaS</b>	Experimentation as a service	<b>LoS-MIMO</b>	Line of Sight Multiple Inputs Multiple Outputs
<b>BSS</b>	Business Support Systems	<b>EC</b>	European Commission	<b>LV</b>	Low Voltage
<b>BSs</b>	Base Stations	<b>eMBB</b>	Enhanced Mobile BroadBand	<b>MANO</b>	Management and Orchestration
<b>BVLOS</b>	Beyond Visual Line of Sight	<b>eSBA</b>	Enhanced Service-Based Architecture platform	<b>MASA</b>	Modena Automotive Smart Area
<b>CAD</b>	Computer-Aided Dispatch	<b>ETSI</b>	European Telecommunication Standards Institute	<b>MB</b>	MultiBand
<b>CAD1</b>	Connected and Automated Driving	<b>EuCNC</b>	European Conference on Networks and Communications	<b>MBDR</b>	Misbehaviour Detection and Response
<b>CAM</b>	Connected and Automated Mobility	<b>FD-canceller</b>	Full Duplexing canceller	<b>MC/MCX</b>	Mission Critical
<b>CAPEX</b>	Capital expenditures	<b>fFDD</b>	flexible Frequency Division Duplex	<b>MCPTT</b>	Mission Critical Push-to-Talk
<b>CBRS</b>	Citizens Broadband Radio Service	<b>FL</b>	Federated Learning	<b>MCR</b>	Master Control Room
<b>CCAM</b>	Cooperative Connected and Automated Mobility	<b>FoF</b>	Factory of Future	<b>ME</b>	Mobile Edge
<b>CCTV</b>	Closed-Circuit Television	<b>FP7</b>	7 <sup>th</sup> EU Framework Programme	<b>MEC</b>	Multi-access Edge Computing
<b>CDN</b>	Content Delivery Network	<b>FRMCS</b>	Future Railway Mobile Communication System	<b>MEC</b>	Mobile Edge Computing
		<b>FVV</b>	Free viewpoint video	<b>METIS II</b>	Mobile and Wireless Communications Enablers for Twenty-twenty Information Society II
				<b>MIMO</b>	Multiple Inputs Multiple Outputs
				<b>ML</b>	Machine Learning





<b>mMTC</b>	Massive Machine Type Communications	<b>PtMP</b>	Point to MultiPoint	<b>SNS JU</b>	European Smart Networks and Services Joint Undertaking
<b>MNOs</b>	Mobile Network Operators	<b>PTP</b>	Precision Time Protocol	<b>SOTA</b>	State Of The Art
<b>MOMDP</b>	Multi-Objective Markov Decision Process	<b>PZT</b>	Piezo-electric-transducer	<b>SRIA</b>	Strategic Research and Innovation Agenda
<b>MoU</b>	Memorandum of Understanding	<b>QoS</b>	Quality of Service	<b>T&amp;L</b>	Transport and Logistics
<b>MR</b>	Mixed Reality	<b>R&amp;I</b>	Research and Innovation	<b>TB</b>	Technology Board
<b>MS</b>	Monitoring system	<b>R1D</b>	Research and Development	<b>TCMS</b>	Train Control Management System
<b>MTD</b>	Mobile Telephony System	<b>RAN</b>	Radio Access Network	<b>TEE</b>	Trusted Execution Environment
<b>MTD</b>	Moving Target Defence	<b>RES</b>	Renewable energy sources	<b>TeSo</b>	Tele-operated Support
<b>MVP</b>	Minimum Viable Product	<b>RF</b>	Radio Frequency	<b>TIRO</b>	Tactile Internet and Remote Operations
<b>MWC</b>	Mobile World Congress	<b>RFIC</b>	Radio Frequency Integrated Circuit	<b>TMC</b>	Traffic Management Centre
<b>NAO</b>	Network Application Orchestrator	<b>RIA</b>	Research and Innovation Action	<b>TSON</b>	Time shared optical network
<b>NBI</b>	North-Bound Interfaces	<b>RIC</b>	RAN Intelligent Controller	<b>UAV</b>	Unmanned Aerial Vehicle
<b>NCC</b>	Network and Computing Convergence	<b>RIS</b>	Reconfigurable Intelligent Surfaces	<b>UCs</b>	Use Cases
<b>NFV/VNF</b>	Network Function Virtualisation	<b>ROS</b>	Robot operating system	<b>UDP</b>	User Datagram Protocol
<b>NI</b>	Network Intelligence	<b>RRH</b>	Remote Radio Head	<b>UE</b>	User equipment
<b>NLOS/LOS</b>	Non Light of Sight / Light of Sight	<b>RSRP</b>	Reference Signal Received Power	<b>UEs</b>	Users
<b>NOW</b>	Network on Wheels	<b>RSRQ</b>	Reference Signal Received Quality	<b>UL</b>	Upload
<b>NOX</b>	Nitric oxide	<b>RSS</b>	Received Signal Strength	<b>uRLLC</b>	Ultra Reliable Low Latency Communications
<b>NPN</b>	Non-Public Networks	<b>RT-HIL</b>	Real-Time Hardware In The Loop	<b>USB</b>	Universal Serial Bus
<b>NSaaS</b>	Network-Slicing as a Service	<b>RTLS</b>	Real-Time Location Systems	<b>UVs</b>	Unmanned vehicles
<b>NSMS</b>	Network Slice manager	<b>RTPC</b>	Remote Transmit Power Control	<b>UWB</b>	Ultra-wide band
<b>OAI</b>	Implementation of Open Source	<b>RTT</b>	Round Trip Time	<b>vCDN</b>	Virtual Content Distribution Network
<b>OEMs</b>	Original Equipment Manufacturers	<b>SAPAAS</b>	Segmented Active Phased Array Antenna Systems	<b>(v)RUs, DUs, CUs</b>	(virtualised) Remote, Distributed, Central Units
<b>ONAP</b>	Open Network Automation Platform	<b>SB</b>	Steering Board	<b>VNE</b>	Virtual Network Embedding
<b>ONF</b>	Open Networking Foundation	<b>SBC</b>	Session Border Controller	<b>VNF</b>	Virtual Network Function
<b>OPEX</b>	Operational expenditures	<b>SCoDIHNet</b>	Smart Connectivity Digital Innovation Hub Network	<b>VOD</b>	Video-on-Demand
<b>O-RAN</b>	Open RAN	<b>SDN</b>	Software-Defined Networking	<b>VPN</b>	Virtual Private Network
<b>OSG</b>	Open-Source Group	<b>SDoF</b>	Single Degree of Freedom	<b>VR</b>	Virtual Reality
<b>OSM</b>	Open Source MANO	<b>SDOs</b>	Standard Development Organisation	<b>VSP</b>	Vertical service providers
<b>OSS</b>	Open-source software	<b>SDR</b>	Software-defined Radio	<b>WGs</b>	Working Groups
<b>OTA</b>	Over-the-Air	<b>SiGe</b>	Silicon-Germanium	<b>xNF</b>	Combination of PNF (Physical Network Function) and VNF (Virtual Network Function)
<b>OWC</b>	Optical Wireless Communication	<b>BiCMOS</b>		<b>XPIC</b>	Cross Polarisation Interference Cancelling
<b>PIS</b>	Passenger Information System	<b>SINR</b>	Signal to Interference & Noise Ratio	<b>XR</b>	Extended Reality
<b>PMR</b>	Progress Monitoring Report	<b>SLA</b>	Service Level Agreement	<b>ZSM</b>	Zero Service Management
<b>PoCs</b>	Proof of Concept	<b>SLAM</b>	Simultaneous Localisation and Mapping		
<b>POV</b>	Point of view	<b>SME</b>	Small and Medium Enterprise		
<b>PPDR</b>	Public Protection and Disaster Relief				

Printed in May 2023  
DÉFI NUMÉRIQUE, Montpellier



This material has been designed and printed with support from the 6GStart project and the 5G/6G Infrastructure association. The 6GStart Project has received funding by the European Union's Horizon Europe Research and Innovation programme HORIZON-CL4-2021-DIGITAL-EMERGING-01 under grant agreement number 101069987.

The European Commission support for the production of this publication does not constitute endorsement of the contents, which reflects the views only of the authors, and the Commission cannot be held responsible for any use which may be made of the information contained therein.



# The European 5G Annual Journal/2023

This material has been designed and printed with support from the 6GStart project and the 5G/6G Infrastructure association . The 6GStart Project has received funding by the European Union's Horizon Europe Research and Innovation programme HORIZON-CL4-2021-DIGITAL-EMERGING-01 under grant agreement number 101069987.

The European Commission support for the production of this publication does not constitute endorsement of the contents, which reflects the views only of the authors, and the Commission cannot be held responsible for any use which may be made of the information contained therein.

Supported by the



**5G PPP**

More information at  
<https://5g-ppp.eu>

