

A 6G vision

6GStart

5G PPP

The 5G Infrastructure Public Private Partnership

What will 6G offer
to vertical industries
& Future perspectives



Funded by
the European Union

Webinar Highlights

Online Event

**A 6G
vision** / 20th April 2023
10:30 - 12:30 CEST

**What will 6G offer
to vertical industries
& Future perspectives**

JOIN US



6GStart
Grant Agreement No.101069987

SPEAKERS



Rahim Tafazoli
Head of the Institute for
Communication Systems
(ICS) at University of Surrey

Alexandros Kaloxylos
6G-IA Executive Director

Artur Hecker
Chair of 6G-IA Vision and
Societal Challenges WG

Håkon Lønsethagen
Co-Chair of 6G-IA Vision
and Societal Challenges WG

Muslim Elkotob
Principal Solutions Architect
at Vodafone

David Boswarthick
Director of New
Technologies at ETSI

Authors:

Claudio de Majo,
Francesco Osimanti
(Trust-IT Services),

Alexandros Kaloxylos
(6G-IA),

Paul Voskar
(Huawei)

Editor

Andrea Greco
(Trust-IT Services)

Date: 2021-05-12
Status: Public Release
DOI: 10.5281/zenodo.7928780

URL: doi.org/10.5281/zenodo.7928780
License: Creative Commons Attribution 4.0
International

A

Introduction

April 20, 2023, saw the organisation of a 5G/6G Vertical Users Workshop aimed at establishing a collaborative event for strategic dialogue between vertical industries (automotive Industrial automation, health, media industry, security, public safety, energy), SDOs and 3GPP to exchange requirements, outline issues and obstacles impeding progress, and look at upcoming future standards development.

The reason for discussing these requirements is their key role in unlocking the potential of 5G/6G technologies, intending to enhance vertical industries

Speakers (in order of appearance)



Alexandros Kaloxylos
6G-IA Executive Director



Artur Hecker
Chair of 6G-IA Vision and Societal Challenges WG



Håkon Lønsethagen
Vice-chair of 6G-IA Vision and Societal Challenges WG



Muslim Elkotob
Principal Solutions Architect at Vodafone



Rahim Tafazolli
Regius Professor & Director of Institute for Communication Systems (ICS) and 5GIC (5G Innovation Centre) at the University of Surrey



David Boswarthick
Director of New Technologies at ETSI

Final Roundtable and Q/A Session from the audience

Speakers



Alexandros Kaloxylos

(6G-IA Executive Director)

introduced the webinar by discussing the main questions assessed by the speakers, such as the economic, societal, environmental and technological impact of the 6G concept, future business opportunities, use cases and key drivers, 6G advantages over 5G, fixed 5G-related shortcomings, potential future standardisation inputs in the EU (and International) R&I for next generation networks and services.

The current 6G developments within the EU originate from 5GPPP (public-private partnership in Horizon 2020), and its related initiatives carried out so far have financed 92 R&I projects, engaged 700 stakeholders, contributed to over 800 standardisation activities, published over 2000 scientific and 40 white papers, and produced 445 innovations as well as multiple technological breakthroughs. These achievements have produced use cases on multiple verticals, from automotive to broadcasting and media, transport and logistics, agriculture, etc.

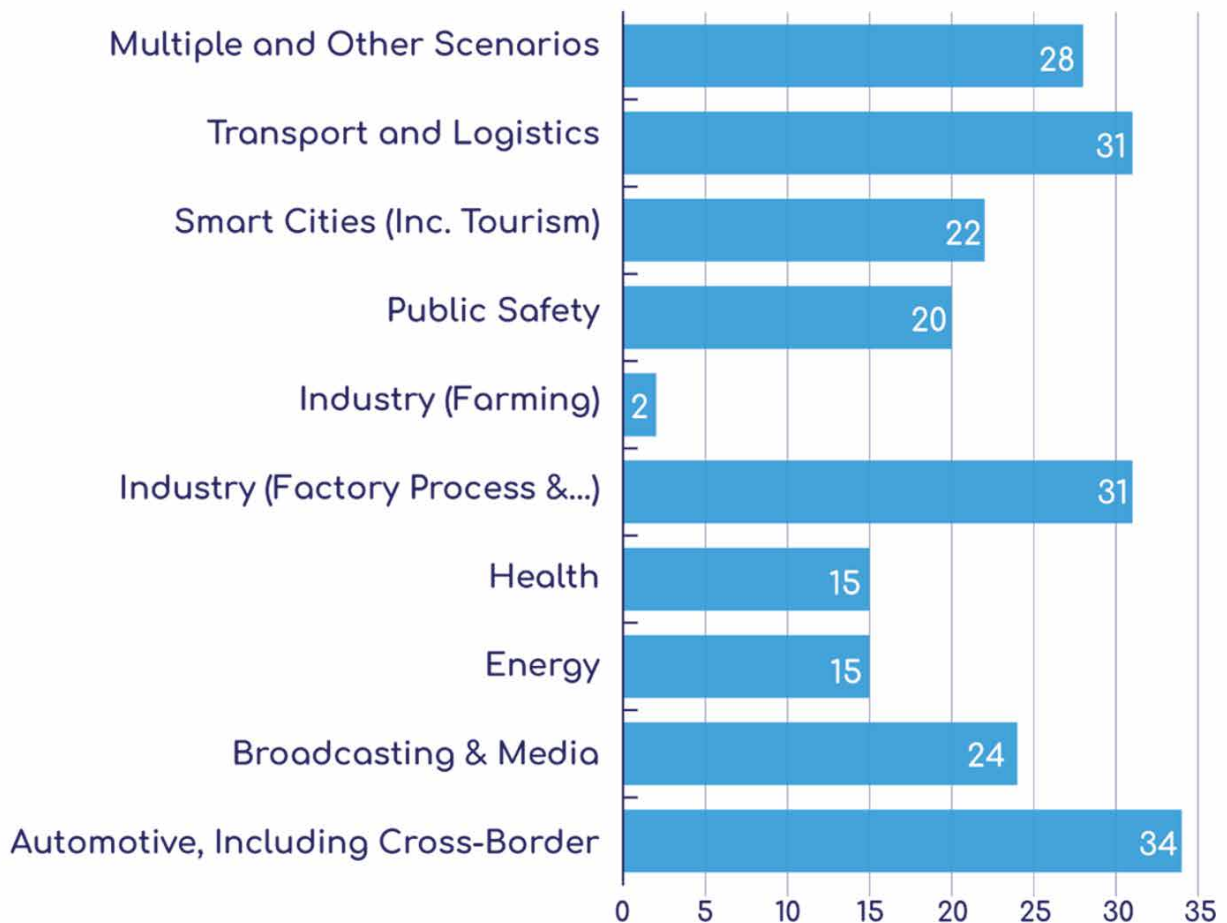

While 5G-related projects are ongoing, the Smart Networks and Services Joint Undertaking (SNS JU, public-private partnership in Horizon Europe) has already started. Overall, it will allocate 900 Million euros publicly funded research program for Next generation networks. The first group of projects began in 2023, and the second call opened in January 2023. Phase 1 mainly focuses on the 5G-6G transition, 6G exploration, concepts and definition. Conversely, Phase 2 will focus on 6G detailed design and system optimisation. A third call for projects is being prepared (currently targeted to open in late October 2023 with a deadline of late April 2024), which should culminate in Phase 3 on developing the 6G pre-commercial industry.

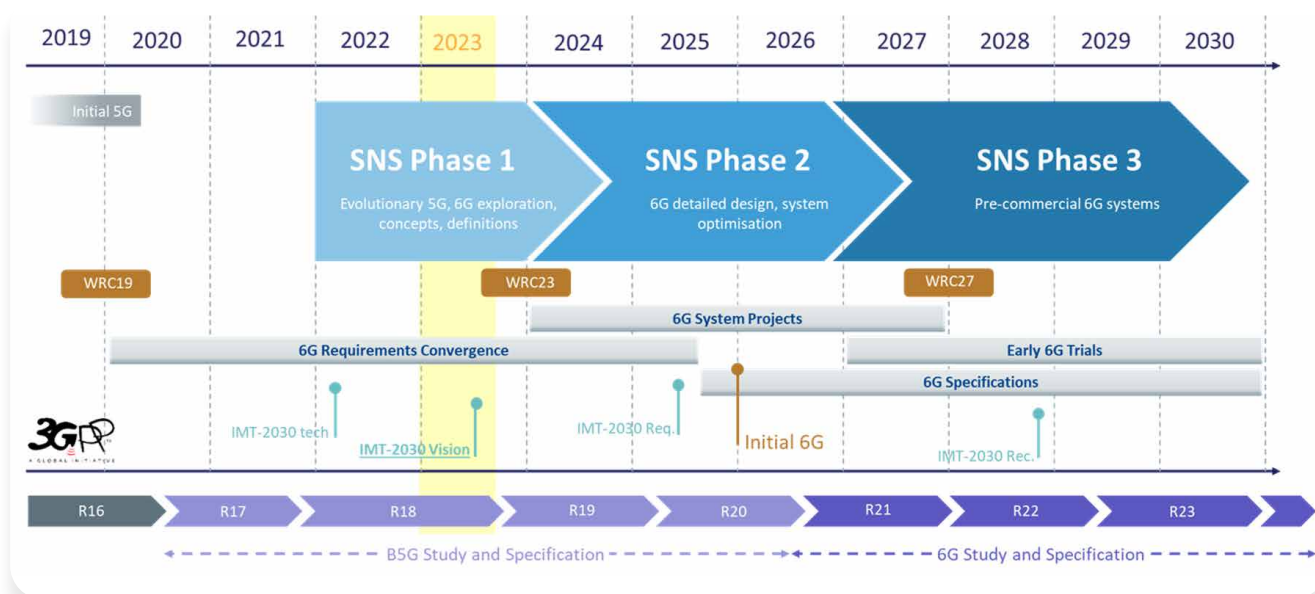

The 6G SNS JU's main strategic objectives include bringing Europe to the centre stage of future connectivity scenarios, mobilising European stakeholders (primarily vertical industries), enabling cross-sector collaboration (through a value-chain approach), making Europe the centre of gravity for international collaboration and global consensus through the creation of a wealthy business ecosystem. At the same time, the 6G networks should also address societal needs, such as supporting the European Green Deal targets of sustainable energy consumption and ensuring the privacy and security of all citizens.



“ The 6G SNS JU’s main strategic objectives include bringing Europe to the centre stage of future connectivity scenarios, turning Europe into the centre of international collaboration through the creation of a wealthy business ecosystem ”

Nobody knows what the research architecture will look like or how it will evolve. However, it is sure that the 6G SNS partnership will cover end-to-end activities such as user equipment (Edge and IoT), 6G RAN, improving activities in the data network (e.g. computational resources), covering end-to-end topics such as security, and engaging verticals and providers. Overall architectural innovations include frictionless management, deterministic networking, new NTN architecture and service provision. Conversely, transformative technologies include nano-things networking and AI technologies for telecommunications.

Such ambitions are reflected in the Phase 1 SNS R&I work programme, tackling topics such as smart communication components, systems and networks for 5G evolution through large-scale SNS trials and pilots engaging multiple verticals and developing new 6G experimental infrastructures.



Artur Hecker

(Chair of 6G-IA Vision and Societal Challenges WG)

discussed the European 6G vision, particularly emphasising the verticals. The presentation provided insights from two whitepapers drafted by 5G PPP, Non-Public-Networks – State of the Art and way forward (2022), and 5G IA, European Vision for the 6G Network Ecosystem (2021).

The presentation outlined the main drivers for the development of 6G. Like any new generation technology, 6G has different drivers based on existing technologies that need improved performance (e.g., new frequency rangers, optical networks). In turn, these actively build from new ideas and societal needs. Thus, technological advancement, new ideas and societal needs often go hand in hand and complement each other. In the specific case of 6G, the three drivers intersect each other as such:

- 1 Technological advancements.** These include improved performance, new frequency ranges and integration with NTN optical networks.
- 2 New ideas.** These involve integrated sensing and communication, compute integration (eventually leading to the possibility of distributed 6G technologies) and the integration of AI/ML mechanisms with the mobile system.
- 3 Societal needs.** These encompass the need to include new use cases beyond usual domains and, notably, new scenarios and users. For example, developing more sustainable and trustworthy telecommunication broadbands.

6G is also reshaping connectivity reality. Until 5G, telecommunications worked as a sandwich, where both endpoints, i.e., servers and clients, squeezed 5G transport systems, strictly separating compute/connectivity. With the advances of 5G, with 6G, a different reality emerges, with different entities working horizontally and locally interacting to simultaneously provide compute and networking services (e.g., densification, disaggregation, proliferation of edge computing and non-public networks leading to open multi-tenancy). Thus, such different participating entities create a new reality formed by the intersection of cloud/network providers and NPN for all network nodes.

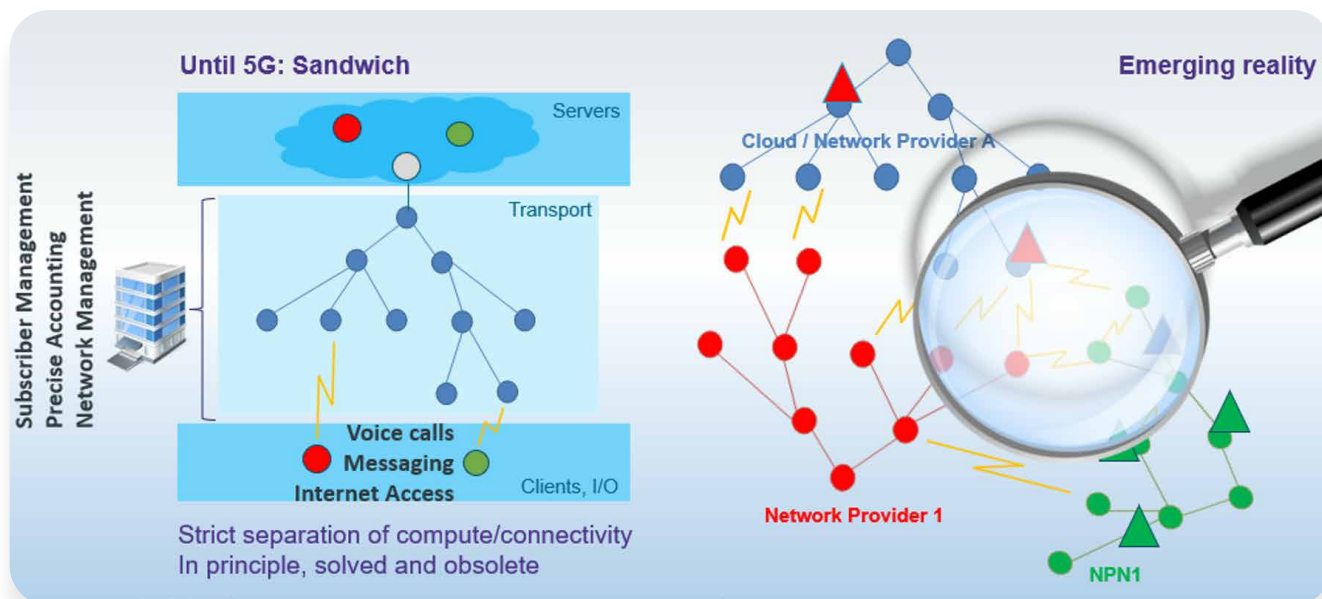

“ 6G offers a different emerging reality, with different entities working horizontally and locally interacting to provide computer and network services at the same time ”

5G has introduced a novel, very successful mode of networking, the Non-Public Networks (NPN) support, which is particularly interesting for vertical industries. As with NPNs, these so-called verticals become direct customers of equipment vendors, they are essentially entering the horizontal market. This, in turn, justifies rethinking the structure of mobile network architecture, and notably of its core network services, incorporating emerging novel system requirements based on entirely local services and open multi-tenancy. This would enable easy deployment, service quality assurance and security for core network support, and radically different scenarios for NPN.

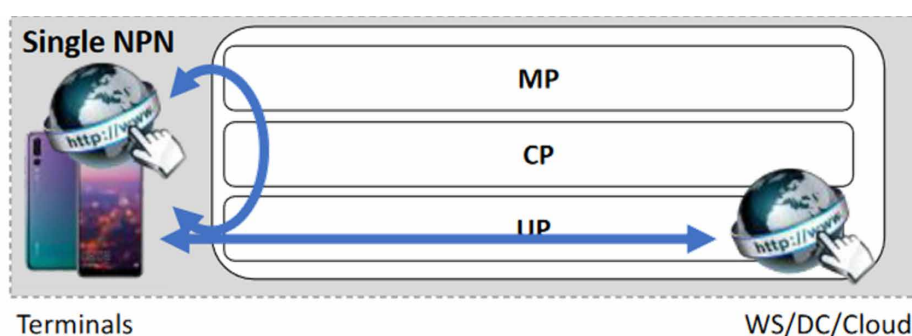

Hence, monolithic system architecture targeting single providers should be abandoned and multi-tenant, cooperative modes in deployment, operations and service provisioning from the design on should be embraced.

It is, therefore, possible to rethink the future of mobile architecture, going from access networks to a common API infrastructure where different types of services can be built, allowing the emergence of new kinds of user functionalities, control management planes, and flexible on-demand infrastructures.

It is, therefore, possible to rethink the future of mobile architecture, going from access networks to a common API infrastructure where different types of services can be built, allowing the emergence of new kinds of user functionalities, control management planes, and flexible on-demand infrastructures.



Håkon Lønsethagen

(Co-chair of 6G-IA Vision and Societal Challenges WG)

complemented Artur's points by tackling issues linked to addressing the complexity of increasing use cases, understanding and mitigating key barriers and the new evolutions.

Currently, several types of networks act in different geographical contexts and allow different use cases. These include Public Networks for General purposes (Telecom General Application Services), Public Networks for Special purposes (Smart City, Automotive, Rail, Public Safety, Agriculture, Aquaculture), Public Network Integrated with Non-public Networks (Event & Arena, Port, Industry Park) and StandAlone Non-Public Network (Factory). These operate in several physical domains, both indoor and outdoor contexts.

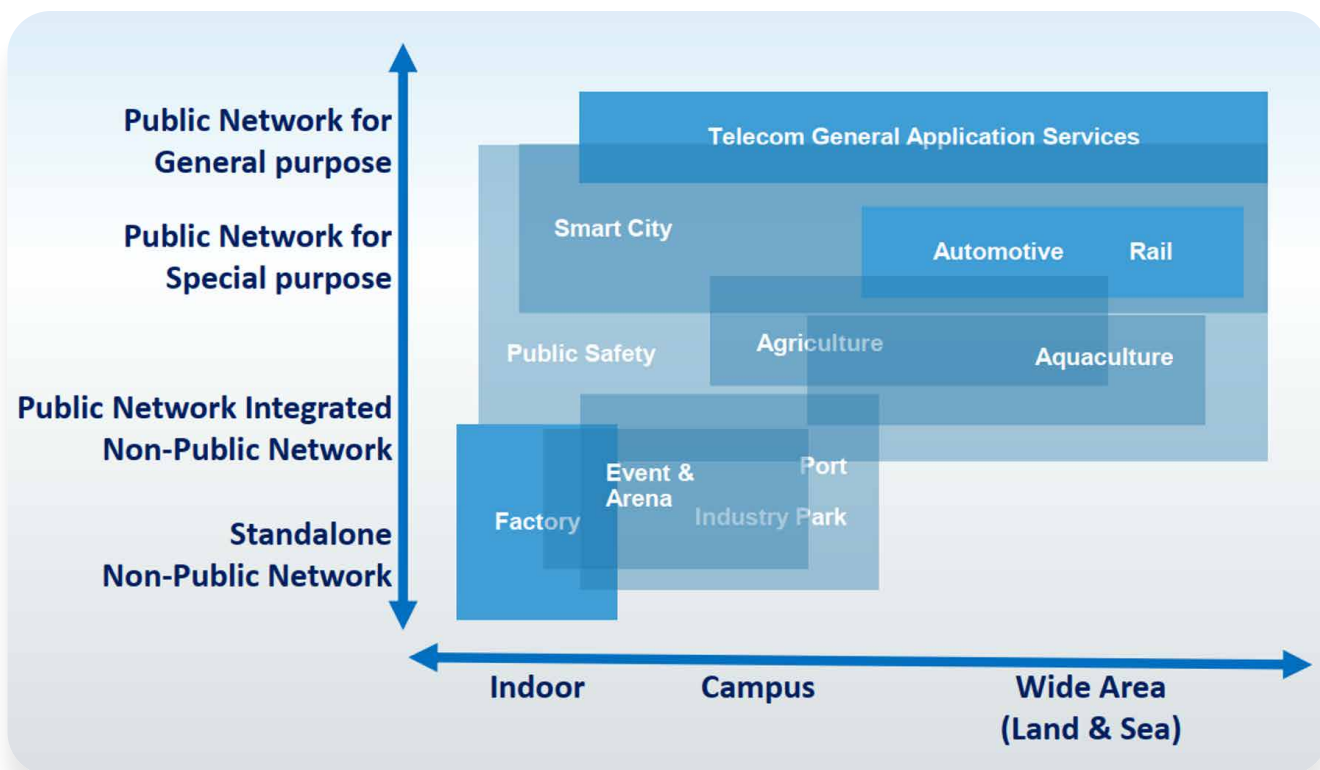

The main question is how society can deal with such complexity. 6G systems have the potential to move beyond point-2-point connectivity, allowing access connectivity, content distribution, positioning, integrated communication and sensing and non-terrestrial networks. This can enable an integrated 6G system approach leveraging a mesh of connections with a control logic from edge to central cloud and In-Network Compute (INC).

These enable new application systems, both online and telecommunications ones. From a services point of view, these include sensing and positioning services, robotics communication services, holographic AR/VR/XR communication services, and Telco Voice Services. Both interconnection and interworking between public telecom networks application services and 5G/6G Basic services are essential.

“ **6G systems have the potential to move beyond point-to-point connectivity, allowing access connectivity, content distribution, positioning, integrated communication and sensing and non-terrestrial networks** ”

Drawing from 5G ecosystems, it is essential to accomplish interconnection and interworking, mitigating barriers in user-application interaction and application-network interaction and better bringing together vertical ecosystems (value creation) and provisioning ecosystems.

To address these complexities, it is necessary to identify 6G archetypes a, understanding key and mitigating barriers for advancing the use of 5G while at the same time ensuring a strong and healthy 6G ecosystem.



Muslim Elkotob

(Principal Solutions Architect at Vodafone)

traced back the main path from 5G New Radio (NR) to 5G StandAlone (SA) and displayed challenges and use case trends across verticals and ecosystem evolution beyond 5G and 6G.

The first step was from 5G NR to 5G SA, with 5G core becoming fully software-based and everything bounded into microservices, completely reshaping the services architecture by allowing breaking down use cases into smaller units.

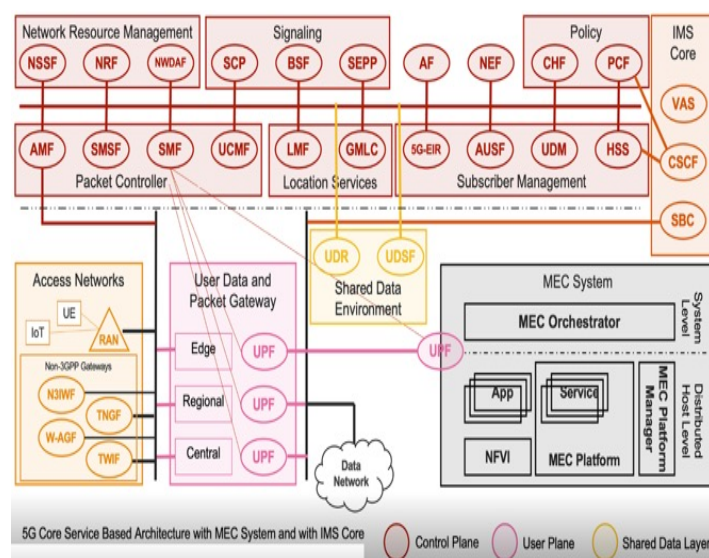
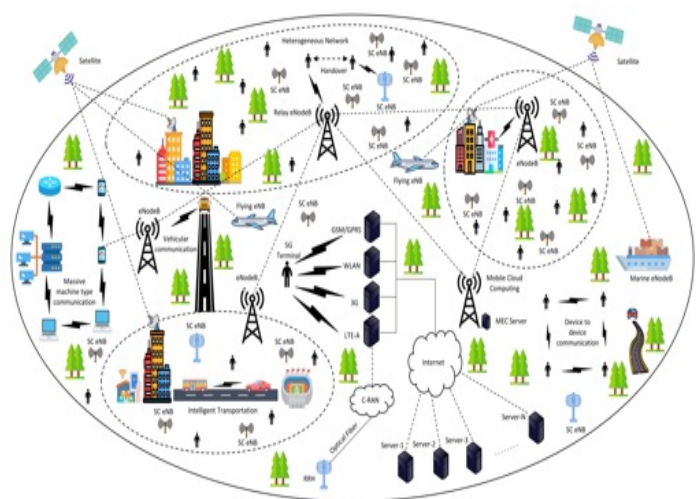

The primary benefit of this technology was the ability to operate an end-to-end core using software applications to slice the core and enable a proliferation of new use cases. In addition, the move toward 6G allowed the creation of more intelligent and precise service networks with more precise grips on resources and new services, better integrating the physical and digital worlds. These include cognition and synched bio, training and control, real-time control and twinning.



The main use cases and new trends across verticals that emerged in 6G include:

- Smart Premium Connectivity, or the so-called “tactile internet”, a very high-efficient and robust connectivity infrastructure supporting many use cases.
- Submersion/Merged Discourses/AR&VR/“Metaverse” seamlessly combining and integrating physical and virtual entities allowing reality simulations.
- Seamless Integration of Cellular, IoT, & Space/Satellite, acting as a coverage compensation entity.
- Mobile Private Networks (Campus, Enterprise).
- Telco Data Sharing, with unprecedented access to data.
- Open Inclusive Ecosystems, disaggregating and combining different connectivity ecosystems (e.g. OpenRAN, VRAN, Multi ISV, SME).
- Smart Edge with new localised cases emerging.

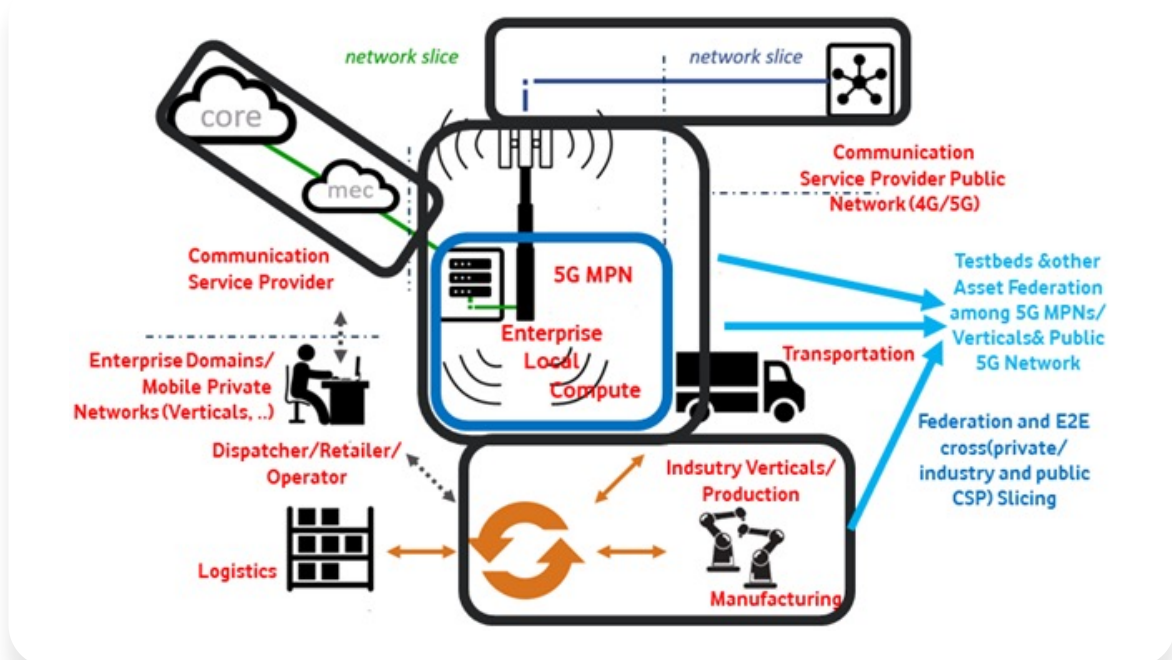

These technological trends allow the creation of different use cases allowed by 6G Systems, including a wide range of domains such as remote healthcare, industrial automation, smart environments, precision agriculture, autonomous vehicles, holographic teleportation, smart infrastructure, space connectivity and UAVs.

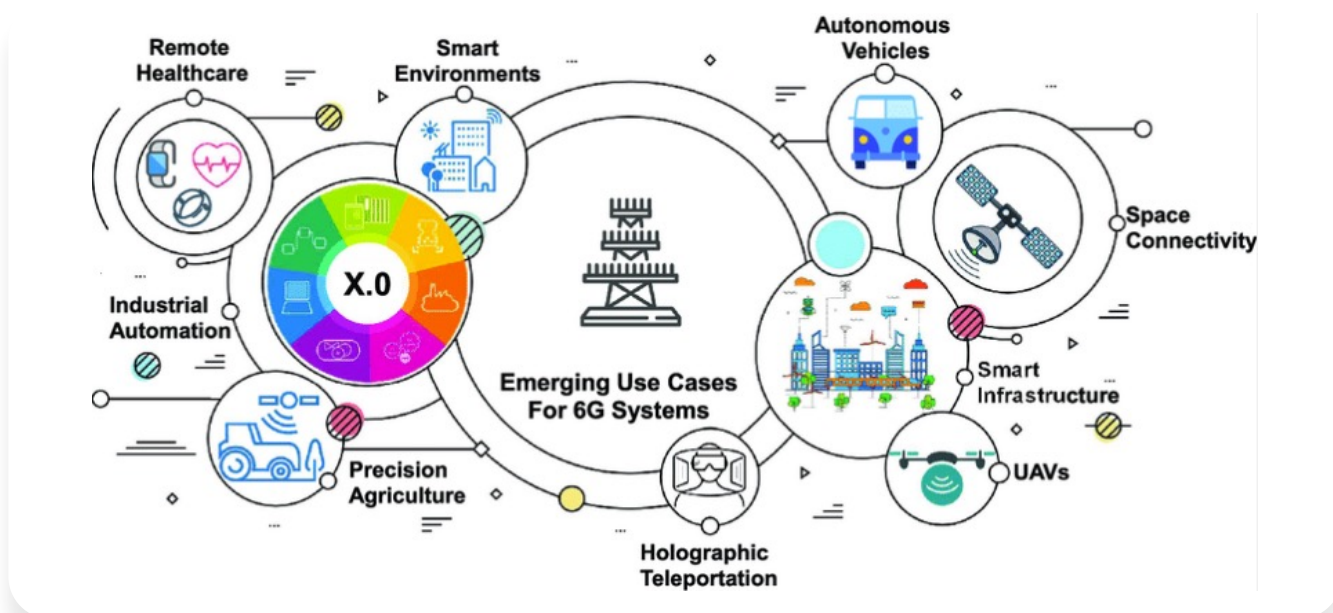

As a result of this ecosystem evolution, corporate strategies have changed. With 5G SA, the service spectrum opens through software-enabled cores, allowing multiple ISVs, AISVs, and SMEs to participate in enabling different use cases. Second, the “mix-and-match” strategy allows best-in-class players (e.g. ISVs) to contribute to the overall offering and run their services as the business values demand. Third, lock-ins (as vendor lock-ins for CSPs) are being broken, and n:m relationships are being established among stakeholders (CSPs, vendors, ISVs, integrators, etc.). Finally, federation, openness and selectivity create collective, collaborative modes in evolving ecosystems, accelerated by 5G SA Core.



“ **As 5G SA Core is enabling the evolution towards a hyper-connected world, eventually leading to 6G, it will be necessary for stakeholders to position themselves in this fast-paced evolution** ”

In conclusion, 5G SA (StandAlone) is a significant catalyst for ecosystem evolution and development, unleashing an enormous potential on both technical and business levels with E2E operations mode (slicing, federation), use cases and business cases tailored to different verticals and an inclusive value-chain model.

As Beyond 5G is taking off with 5G SA Core and enabling the evolution towards a hyper-connected world eventually leading to 6G, it will be necessary for stakeholders (including CSPs) to position themselves in this fast-paced evolution, balancing factors like key drivers for B5G&6G Business Cases, incoming generation benefits (6G over B5G), and new intra-ecosystem order.



Rahim Tafazoli

(Regius Professor & Director of the Institute for Communication Systems and 5G Innovation Centre at the University of Surrey)

discussed the main reasons behind the existence of 6G – that is, the creation of use cases able to combine environmental, societal and economic challenges successfully.

In terms of environmental challenges, ultra-high energy efficiency is certainly the main asset since 6G might allow to maximise consumption efficiency to over 100% compared to the lower numbers of technologies such as 4G and 5G. Furthermore, reliability for everyday private and industrial contexts is certainly the leading issue among societal challenges. Finally, in economic terms, bridging the digital divide and creating new business use cases is undoubtedly an essential asset.

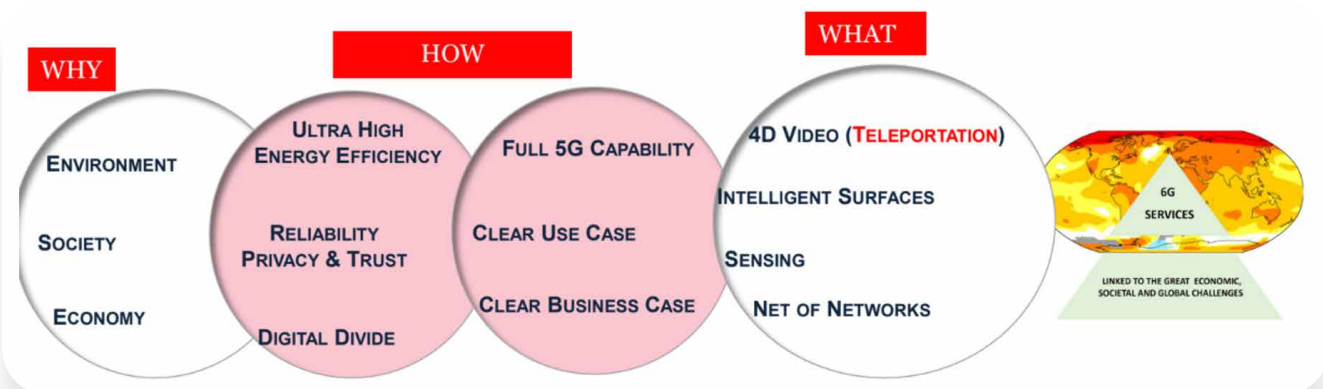

The most probable future vision of 6G is a decentralised network of networks where coverage, synchronisation and sensing converge. An essential aspect to guarantee this transition is to assess a series of research challenges. These imply, first of all, bringing multi-disciplinary research into key enabling technologies (e.g. super fine time synchronisation, ultra-high accuracy geolocation, exceptionally low latency, AI and quantum, sensing (THz) and memoryful networking), developing infrastructure research to deliver coverage ubiquity for the new services (e.g. direct satellite-to-user, large, intelligent surfaces and ultra massive antenna arrays) and develop new service possibilities through extending human senses in a fusion of the virtual and physical world (e.g. 4-D video, enhanced Edge to User environment).

“ Sensing is expected to provide efficiency on all layers of the communication spectrum, improving energy efficiency and enabling smarter applications ”

These technologies would eventually allow the development of future sensing networks based on a brain (semantics & AI), a heartbeat (Synchronisation) and freedom (virtualisation, softwarisation). Such principles are at the heart of the TUDOR national program (Towards Ubiquitous 3D Open and Resilient Network), which integrates satellites into mobile systems to provide an integrated user experience.

In this context, sensing is essential as it is expected to provide efficiency on all layers of the communication spectrum, improving energy efficiency and enabling smarter applications. Two categories of sense are autonomous networks and ambient user levels.

Potential use cases would help network operations from a management and efficiency standpoint. These include interference management through traffic sensing, intelligent surfaces redirected through blindspots, resource management such as traffic location, coverage extension through EM sensing and channel equalisation through a change of environment sensing.

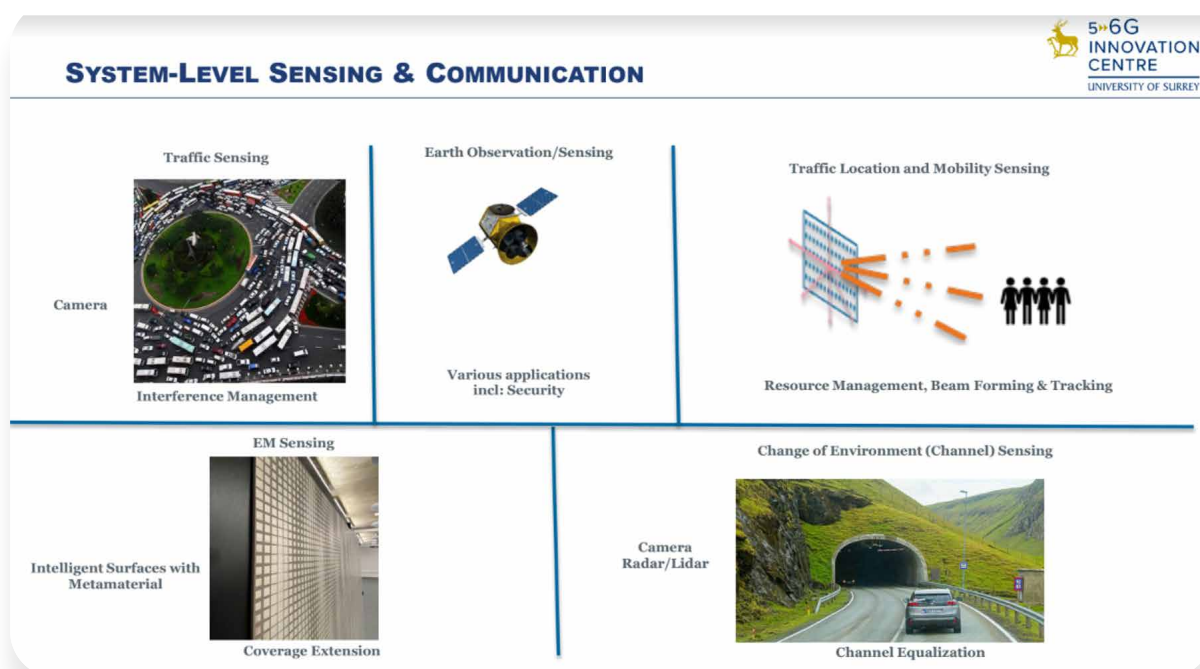

Physical and virtual role interactivity also require time synchronisation to achieve a more efficient sensing information system which could allow interactivity in integrated physical-cyber domains. Time synchronisation could allow low latency-based traditional use cases to evolve into a new set of use cases based on applications such as interference management, earth sensing, beam forming coverage extension and channel equalisation.

Potential examples include connected vehicles to high-speed driver-less and cooperative driving, from manufacturing to interactive, cooperative manufacturing, from entertainment to interactive entertainment, from healthcare to interactive telecare, and from education to interactive tele-education.

Moreover, new 6G-enabled applications such as soft terahertz could take sensing one step further. While traditional communication relies on human senses such as sight and hearing (audio and

video), the union of technologies such as virtual reality, synchronisation and user-level sensing information could allow the transmission of other human senses such as touch and smell and other ambient factors, enabling a virtual teleportation process.



David Boswarthick
(Director of New Technologies at ETSI)

finalised the panel, discussing how standards can contribute to developing 6G technologies. In particular, ETSI technology radar detected some key areas (Tech Trends) for developing future standards. These include Mobile Network Evolution and new trends linked to telecommunications, such as optical wireless communications, non-terrestrial networks and integrated sensing and communicating networks will be developed in the upcoming years.

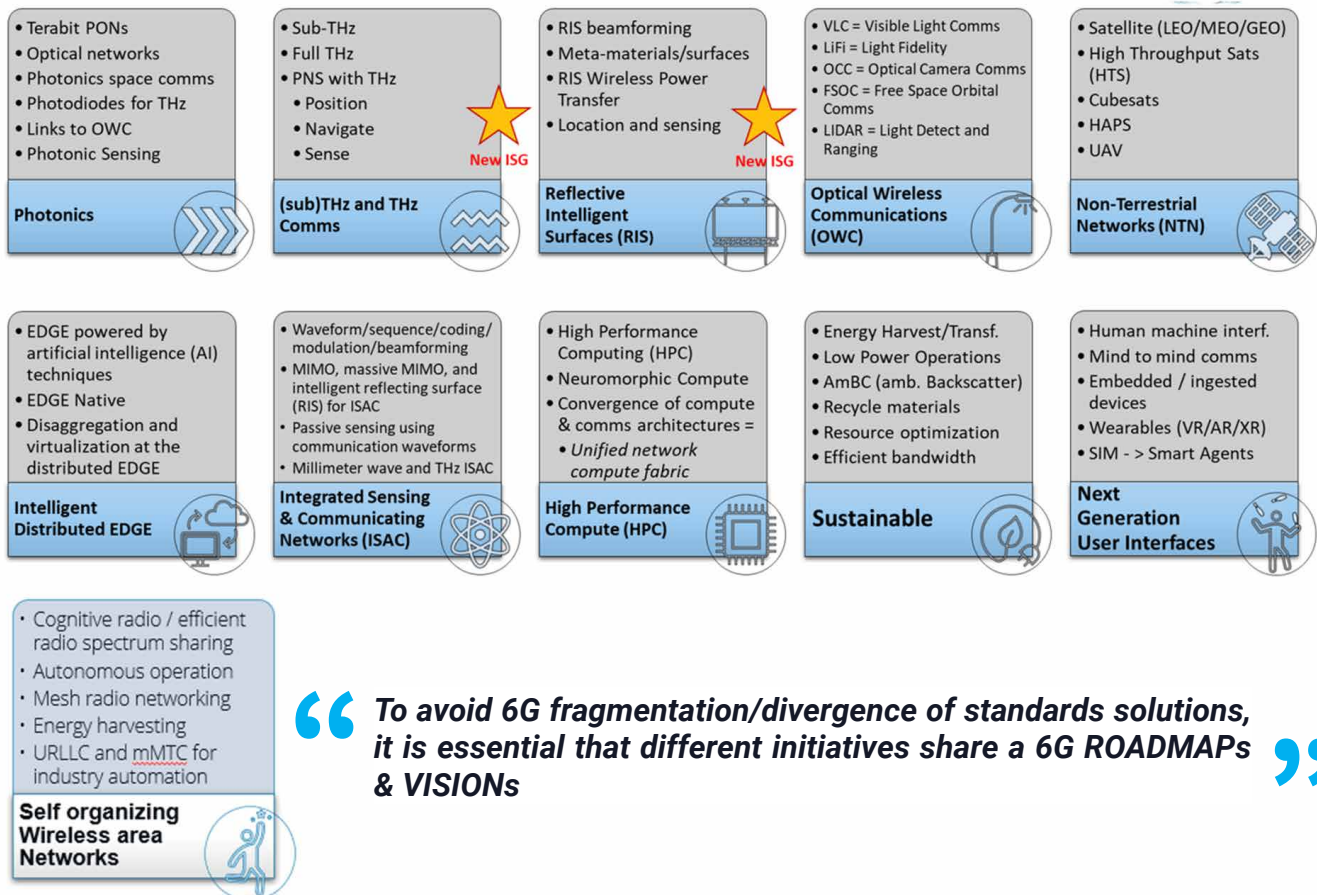

As to 6G, the first early services of 6G might be deployed in 2030, although some earlier deployments could take place by 2028 due to increasing expectations and market pressures, as witnessed by the proliferation of announcements of national, regional and corporate 6G programmes and visions. The reason for such a timeline is that 6G is currently only at the Research & Vision phase, considering that most verticals still utilise only 5G. Conversely, 6G consolidates collective efforts and vision papers, which should help consolidate standards when the first applications are released.

However, to avoid 6G fragmentation/divergence of standards solutions, the early sharing of 6G ROADMAPs & VISIONs between regional initiatives is essential. 6G is indeed expected to begin in 3GPPP in Rel-20 (initial studies), while Rel-21 should start analysing service requirements (most likely by 2026). There is thus a window of opportunity by 2026 for SNS projects to start to mature their concepts and get ready to standardise their results by carrying out gap analyses and output capitulation to optimise time and effort. Evidence of these early discussions is the presence of some “commonly identified” use cases, performance expectations and candidate 6G technologies.

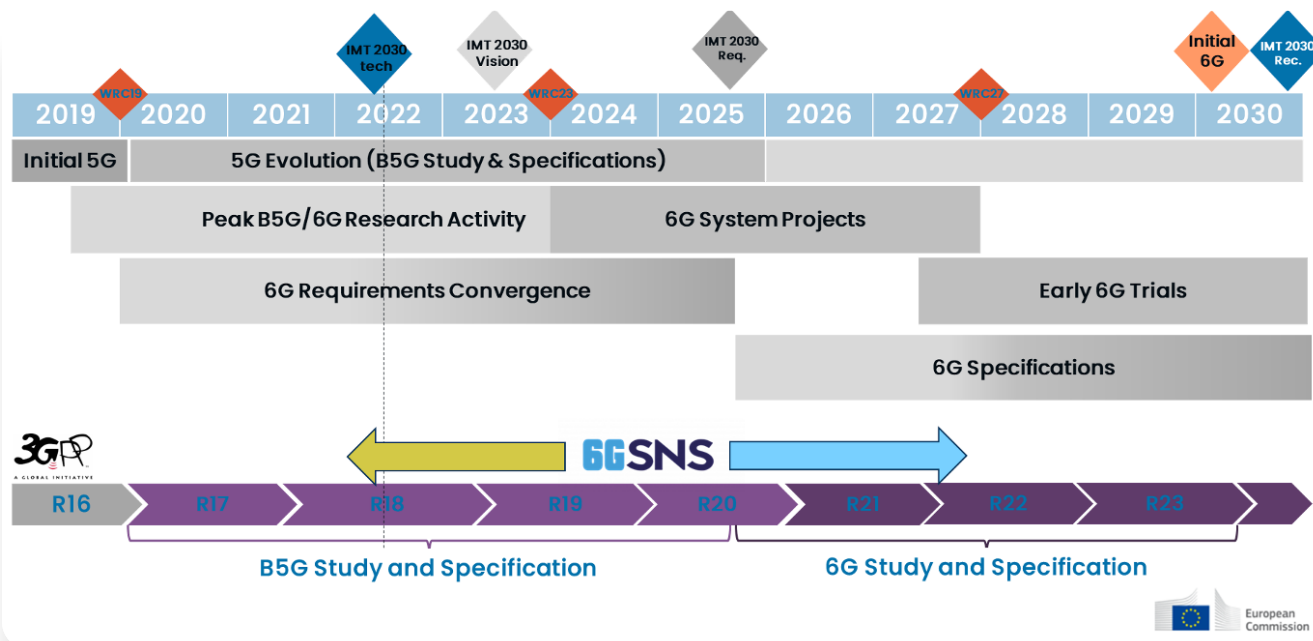

However, 6G already brings several challenging topics to emergence, such as quantum networks (sub) THz, reconfigurable intelligent surfaces, integrated sensing and comms, shared spectrum, advanced MIMO, non-terrestrial networks, AI native, optical wireless comms, sustainable networks.

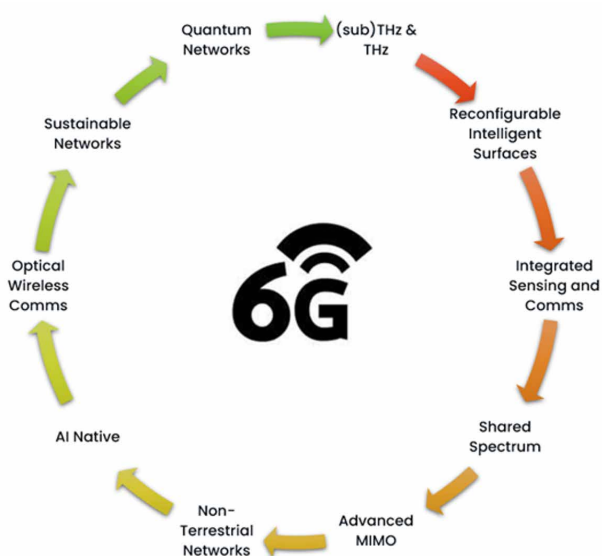

Although there is currently no consensus about what 6G technologies are, since 6G is a more human-centric technology, they will most likely be a mix of evolutionary technology developments. They will probably build on 5G evolutions and revolutionary technology leaps requiring a “new” Generation of technology-building blocks. For this reason, Key Value Items (KVIs) such as trust, privacy and security should receive more emphasis than they did in 5G developments. ETSI is already preparing for such changes, developing discussions on technologies such as sub/full THz Comms, Reconfigurable Intelligent Surfaces (RIS), and Integrated Sensing and Communications (SCN).



Roundtable discussion

A roundtable discussion closed the webinar with the discussion of some key questions. The first two questions concerned the relation between 6G and standardisation practices.

The first one discussed the risks of standardising technologies that have not been investigated satisfactorily yet. **David** responded that this is a relatively common risk in standardisation practices, where standardisation processes can have either positive or negative outcomes depending on the maturity of the given technology. Therefore, pre-standardisation groups are essential to fill these gaps and create a community around certain technologies so that discussions can mature when the innovation is ready.

The second question concerned KVIs and how these will impact 6G research in the future. **David** highlighted that since 6G will probably include more human values, it would be essential to effectively involve KVIs in future standardisation practices. **Alex** complemented by noticing that 6G-IA is also aiming in this direction, as witnessed by a vision paper that the association is currently drafting.

The roundtable discussion shifted to the 6G application, with a question on the most game-changing technological enabler. **Rahim** remarked that intelligent surfaces would play a central role in solving social and environmental issues, allowing optimised and user-centric applications. A second enabler from a use-case point of view is time synchronisation, which would enable XR innovations, mainly virtual teleportation. Non-terrestrial networks will also provide a cost-effective solution for ubiquitous coverage. **Artur** complemented with in-network computing, which might profoundly change how systems are used and allow technological advancement, providing service-neutral infrastructures. These will create platforms open to all users, allowing dense infrastructures.

A follow-up question was about operators' trust towards autonomous networks. **Rahim** remarked that AI-enable automation is an important research area to prove to service providers that they can rely on these for reliable and trustworthy communications. **Hakon** commented that autonomous networks must comply with specific security requirements to make them entirely trustworthy. **Muslim** provided insights from automation, remarking that operators have struggled to ensure KPI performance while keeping up with application prices and that new IT services will be essential for future developments.

Finally, 5G promises for verticals were assessed, emphasising the main obstacles they encountered to develop thoroughly (see poll questions 3 and 4). **Muslim** remarked that 5G StandAlone technologies had allowed the development of several use cases but took a long time to officially kick-off. For this reason, a massive set of use cases was developed, but these were relatively unprofitable. Avoiding a slow start with few business use cases is a lesson that 6G should strive to learn, immediately detecting business and social drivers and potential SDOs, and driving 6G towards societal demands from day one. **Hakon** complemented by stating that linking standardisation practices with the most agile technologies would be essential to speed up application processes. **Artur** observed how 5G had begun a path towards autonomous unlicensed access, a process that facilitates connectivity integration that 6G should strive to follow. **Rahim** wrapped up by reminding that although from a technological and standards perspective, 5G has been successive, in several European countries, vertical integration is still unsatisfactory. It is, therefore, essential not to confuse adoption with the effectiveness of 5G technology, which significantly improved connectivity.

D

Appendix

Webinar Poll Questions

Poll 1:

Which of the following features do you consider will make the difference on 6G networks

- a. Enhanced Radio Systems (further improvements on delay, throughput, reliability, spectral efficiency) - 10%
- b. More flexible end-to-end architecture - 25%
- c. Enhanced network and service security provision - 5%
- d. Native AI/ML network operation - 40%
- e. Significant improvements in energy efficiency for network devices - 13%
- f. Innovative integration with satellite systems to improve coverage - 7%

Poll 2:

Considering that sustainability is based on three pillars (economic, environmental and societal), what are the most important aspects of 6G networks?

- 1. Business sustainability for verticals, operators and manufacturers - 30%
- 2. Energy efficient solutions - 40%
- 3. Human-friendly solutions (e.g., addressing EMF concerns, antenna densification) - 10%
- 4. Secure communication for citizens - 6%
- 5. Social inclusion - 14%

Poll 3:

Do you believe that 5G has delivered on its promises in relation to verticals?

Yes - 10%

No - 36%

Partially - 54%

A 6G vision

What will 6G offer to vertical industries
& Future perspectives

Poll 4:

In case you consider that 5G could present a greater and faster adoption by verticals, what do you consider as the key obstacles?

1. Lack of understanding of 5G capabilities by the verticals - 10%
 2. Lack of understanding of the verticals' needs by the ICT experts - 20%
 3. The required cost to upgrade existing equipment and adopt 5G as their main connectivity solution - 13%
 4. The required time to update their business process and services to take advantage of 5G solutions - 46%
 5. Lack of integrators to provide complete services to verticals - 11%
-

Poll 5:

What time frame do you expect the start of 6G Standardisation to happen?

- a. In the Short-term (in 1 year) - 8%
- b. In the Medium-term (1 to 3 years) - 46%
- c. In the Long-term (3 to 5 years) - 46%

6GStart

5G PPP

The 5G Infrastructure Public Private Partnership

